



Woodworking machinery and tools



2019 | 2020



General catalogue

Professional solutions

General catalogue

The use of the latest technology and the application of strict quality controls during the design and manufacturing process allows us to present an advanced, solid and safe range of woodworking machinery.



www.virutex.es



index

Planers | 6 - 14

Large planers | 6 - 7
Hand planers | 7 - 8
Chamfering planer | 8
Shape planer | 9 - 10
Edge lipping planer | 11
Curved planer | 12
Abrasive planers | 13 - 14



Installation and restoration of doors and windows | 54 - 67

Slotting machines | 54 - 55
Insulating joints | 56
Frame cutting machines | 57 - 59
Router for fitting hinges | 60 - 61
Template-holders for fitting hinges | 62
Routing head for hinges | 63
Corner chisel | 63
Accessories for doors | 63 - 64
Lock mortiser | 65 - 66
Lock mortising template holder | 66
Template for placing doors frames | 67



Sanders | 15 - 23

Belt sanders | 15
Orbital sanders | 16 - 17
Light sanders | 17 - 18
Rotary orbital sanders | 19 - 20
Wall sanders | 21
Disc sanders & brush sanders | 22
Grinders | 22
Sanding material | 23



Trimmers & routers | 24 - 53

Trimmers | 24 - 28
Routers | 29 - 33
Accessories for routers | 34 - 39
Jointing machine | 40 - 44
Trimmers & routers for solid surface materials | 45 - 47
Professional bits & tools | 48 - 53



Machines for parquet industry | 68 - 69

Trimming machine | 68
Corner trimmer | 69

Cordless drill/driver | 70

Pictographs description

- | | | | |
|--------------------------|--------------------------------|---------------------------|--|
| Double isolation | Electronic temperature control | Chips outlet | Constant speed through electronic system |
| Capacitor | Blade-holder brake system | Reversible knives | Transport case |
| Progressive starting | Security switch | Pendular movement control | Saw blade quick changing system |
| Electronic speed control | Dust collector connection | Velcro sanding papers | |
| Electronic clutch | Dust collector | Standard sanding papers | |

Saws | 70 - 81

- Jig saws | 70
- Circular saws | 71
- Cutting guide | 72
- Plunge-cut saw | 73
- Mitre saws | 74 - 79
- Angle copier | 80
- Movable working table | 80
- Saw blades | 81 - 82



Hand gluers | Clamping systems Professional accessories | Heat gun | 89 - 96

- Hand gluers | 89
- Clamping systems | 90 - 94
- Multiguide T | 95
- Multiguide for joints with dowels | 96
- Heat gun | 96

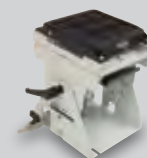

Dust collectors | 83 - 85

- Professional dust collectors | 83 - 85



Edgebanding | 97 - 118

- Edgebanders for pre-glued tapes | 97 - 103
- Manual edge trimmers and scrapers | 99
- Hand end trimmers | 100 - 101
- Hot melt edgebanders | 104 - 116
- Automatic corner round trimmer | 109
- Pre-gluer for tapes | 117 - 118



Laminate cutters | 86 - 88

- Mitering cutter | 86
- Laminate cutters | 86 - 87
- Laminate presser rollers | 88



Specifications subject to change without previous notice.



Leader in woodworking machinery and tools

Since the appearance of Virutex in the market in 1962, we are known to produce high quality and modern woodworking solutions. With our robust, safe, reliable and precise machinery, Virutex meets the expectations of the woodworking professionals from all over the world, and we are among the leading companies within our field.

There are more than 2.000 dealers of Virutex in Spain. We also have clear international vocation, our products can be found in 60 countries over the five continents.

We regularly attend the most prestigious woodworking exhibitions in the world, which helps us to follow the latest market tendencies and keep our quality standards.

Our aim is to keep growing. We have two manufacturing plants in the area of Barcelona, one in Rubí and another in Barcelona city. In Rubí we have our own aluminium foundry and specific departments for thermoplastics injection and metal transformation. The plant in Barcelona accommodates the offices, R+D department, assembly lines and the main warehouse.



In VIRUTEX we manufacture the main part of the components for our machines. This internal control of the production process enables us to initiate our rigorous quality control in the selection of the basic components. Technologically advanced systems and CNC machines are used from the beginning of the manufacturing process to obtain components and parts of the highest precision and quality. VIRUTEX motors are checked one by one before assembly of the machines. Also after the assembling each machine is individually checked to ensure the perfect final performance. In addition, random samples are taken to undergo the more stringent endurance tests, by being made to work under more adverse conditions.





Commitment to innovation and technology

Our technicians are equipped with advanced systems and modern laboratories, where the new VIRUTEX machines can be designed and tested, in order to meet the most strict quality and safety regulations.

We entirely design and produce our machines, which is our branding element. We do not spare time and means to become a benchmark in safety and quality standards. As a result the woodworking machines and tools from VIRUTEX have achieved a well earned reputation for robustness and reliability. With an optimal price - quality ratio, our machines are precise, safe, easy in use and have a guarantee of a product 100% Made in Spain.





GR120P | Large planer

Equipped with a 442 mm length base and perfectly balanced it is specially designed for planing doors or other wooden pieces besides the usual applications for a professional planer. Equipped with several electronic devices for more safety and comfort. Ergonomic design for hand- or left-handed people without distinction. Provided with replaceable carbide reversible blades, carrying case and dust collector connection.



Cutting depth adjuster with automatic graduations of 0.2 mm.



Shavings ejection selector lever (right-left). Dust collector connection on both sides.



Rest shoe to avoid the blades touch and damage the surfaces.

Sliding horizontal guide for planing overlaps of 0-1 mm.



The GR120P is the only planer, together the model CE120P, that permits lateral planing of overlaps of up to 1 mm and a maximum cut height of 25 mm.

With carrying case.

Blades

- 2031082 Set of 2 holders with 3 mm HSS reversible rustic blades
- 2031079 Set of 2 HSS reversible rustic blades 3 mm

Optional accessories

- 2000150 Planer base for using the planer in a stationary position. With blade protection
- 2045381 Micrometric fence for making bevelled edges



Micrometric fence for making bevelled edges at different angles.

Specifications



Input power	900 W
Cutting width	82 mm
Cutting depth	0-4 mm
Rabbeting depth	25 mm
No-load speed	12,500/min
Weight	4.6 kg



CE24E | Large planer

Designed and manufactured for heavy work with the highest standards of quality. The single piece housing is made entirely of aluminium. Planing base 455 mm length. The high power rating of 1,200 W allows it to perform the heaviest and most demanding types of work. Equipped with replaceable carbide reversible blades and dust collector connection.



Dust collector connection.

With carrying case.



Micrometric fence. For making bevelled edges at different angles.

Optional accessories

- 2250012 Planer stand for using the planer in a stationary position
- 2200018 Micrometric fence for making bevelled edges

Blades

- 3540118 Set of 2 carbide reversible blades
- 3531019 Set of 2 HSS reversible blades
- 3599101 Reversible blades holder



Planer stand. To be fixed to a workbench for using the planer in a stationary position.

CE120P | Hand planer

It has been specially designed to be highly ergonomic and therefore to adapt easily to professional use. This machine is comfortable to use and well balanced, guaranteeing comfort and precision. It is equally suited to left- and right-handed use. Planing base 316 mm length. Equipped with blade-holder brake, rest shoe, double regulation and some other features similar to model GR120P.



Adjustable lateral shoe for rabbeting up to 25 mm.

Provided with replaceable carbide reversible blades and dust collector connection.

Optionally it can be delivered with carrying case.



Shavings-ejection selector lever (right-left).

Optional accessories

- 2045381 Micrometric fence for making bevelled edges
- 2000150 Planer stand for using the planer in a stationary position

Blades

- 2031082 Set of 2 holders with 3 mm HSS reversible rustic blades
- 2031079 Set of 2 HSS reversible rustic blades 3 mm



Planer stand. To be fixed to a workbench for using the planer in a stationary position.



Specifications

Input power	1,200 W
Cutting width	80 mm
Cutting depth	0-3 mm
Rabbeting depth	22 mm
No-load speed	13,100/min
Weight	6 kg



Specifications

Input power	750 W
Cutting width	82 mm
Cutting depth	0-4 mm
Rabbeting depth	25 mm
No-load speed	13,000/min
Weight	3.8 kg



CE35E | Hand planer

Its power rating (700 W) combined with its lightness make this model ideal for work both within and away from the shop. Easy to handle and carry. Planing base 290 mm length designed to achieve perfect planing. It is provided with replaceable reversible carbide blades and dust collector connection.



Ideal for jobs both in and away from the workshop.



Planer stand. To be fixed to a workbench for using the planer in a stationary position.



Optionally it can be delivered with carrying case.

Optional accessories

- 3500053 Planer stand for using the planer in a stationary position
- 6446073 Standard dust collector attachment 2.25 m
- 1746245 Standard dust collector attachment 5 m

Blades

- 3540118 Set of 2 carbide reversible blades
- 3531019 Set of 2 HSS reversible blades
- 3599101 Reversible blades holder

CE89E | Chamfering planer

Light, professional, powerful chamfering planer. Equipped with replaceable reversible carbide blades which do not require adjustment. Also equipped with dust collector connection and connection cord 5 metres long.



Specially designed for edge chamfering.



With carrying case.



Connection to dust collector with the standard dust collector attachment (optional).

Optional accessories

- 8946107 Planer stand for using the planer in a stationary position
- 6446073 Standard dust collector attachment 2.25 m
- 1746245 Standard dust collector attachment 5 m

Blades

- 3540118 Set of 2 carbide reversible blades
- 3531019 Set of 2 HSS reversible blades
- 3599101 Reversible blades holder



Planer stand for using the planer in a stationary position.

Specifications

Input power	700 W
Cutting width	80 mm
Cutting depth	0-3 mm
Rabbeting depth	11 mm
No-load speed	16,500/min
Weight	3.2 kg



Specifications

Input power	700 W
Cutting depth	0-12.5 mm
Cutting width at 90°	25 mm
No-load speed	16,500/min
Weight	3.3 kg





FR98H | Shape planer

Designed for shaping the edges of longitudinal beams and crossbeams and modeling coffered ceilings. Factory fitted with two different sets of blades, with their correspondent cutter-holders, for moulding and bevel edging. Using the optional blades, with different radius and profiles it is possible to obtain a great variety of different finishings. The width of the straight or moulded profile obtained can be set between 0 and 40 mm. The guide on which the piece to be shaped rests can be moved with respect to the blades, which means that different profiles can be made on an edge, according to the zone of the blade on which work is being done. There are two handles, one parallel to the main grip and at the same level, allowing a comfortable work on longitudinal beams and vertical parts, and a top knob with two optional positions for work on horizontal surfaces, thus in both cases allowing a perfectly comfortable and secure two-handed grip on the machine. Machine equipped with a smooth electronic starting system and safety connection cut-off switch to avoid undersired start-up. It is also equipped with a dust collection nozzle.



Safe and comfortable handling.



Radiuscopier (optional). Edge rounding or cutting on radius (R=5, 10 or 15) is also possible using radius blades 9841005.



Base with guide extension Ref. 9800050 (Optional).

Types of profiles



Blades and cutter-holders (included with standard equipment)

Ref.	Description
9841004	Set of two carbide straight blades
9845239	Cutter-holder for straight blades
9841006	Set of two carbide moulding blades
9845273	Cutter-holder for moulding blades

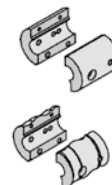

Blades and cutter-holders (optionals)

Ref.	Description
9841005	Set of two carbide blades for 1/4 R=5, 10 & 15
9845270	Cutter-holder 1/4 R=5, 10 & 15
9841010	Set of two carbide blades for 1/4 R=25
9845271	Cutter-holder 1/4 R=25
9841011	Set of two carbide blades for 1/2 R=4,5 & 7
9845272	Cutter-holder 1/2 R=4,5 & 7

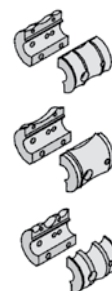

Blades and cutter-holders (optionals)

Ref.	Description
9841012	Set of two carbide blades R=25
9845332	Cutter-holder R=25
9841013	Set of two carbide blades R=20/90°
9845333	Cutter-holder R=20/90°
9841014	Set of two carbide blades R=10 and 10
9845334	Cutter-holder R=10 and 10
9841015	Set of two carbide blades R=5, 20 and 5 180°
9845335	Cutter-holders R=5, 20 and 5 180°
9841016	Set of two carbide blades R=-20
9845336	Cutter-holder R=-20
9841017	Set of two carbide blades R=-7,7,7 γ-7
9845337	Cutter-holder R=-7,7,7 and-7

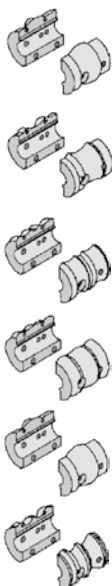

Specifications

Input power	1,300 W
Maximum cutting width	40/20 mm
No-load speed	23,000/min
Max. blades pitch diameter	49 mm
Weight	4.9 kg











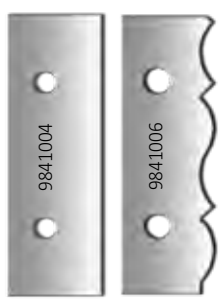
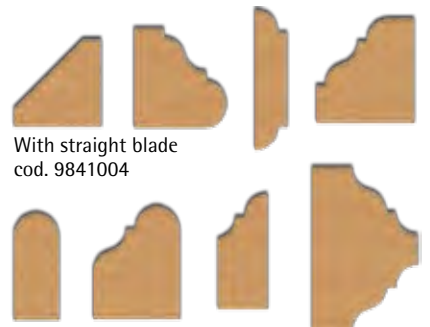

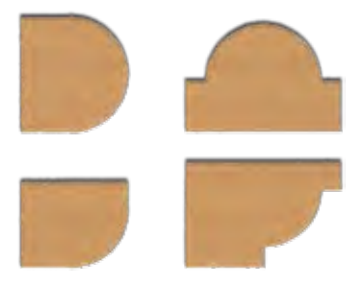

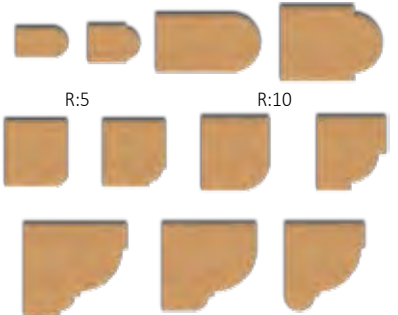

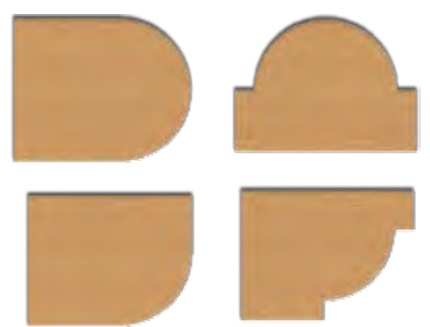

Optional accessories

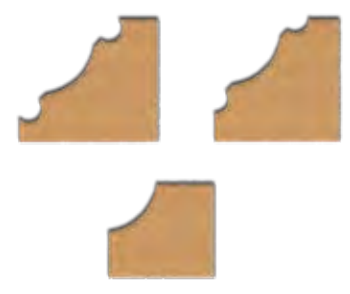
9800150 Radius copier. Allows straight chamfered edges to be made on pieces with exterior circular curves

6446073 Standard dust collector connection 2.25 m

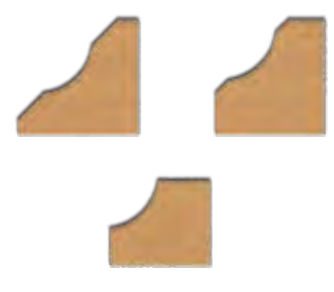
1746245 Standard dust collector attachment 5 m

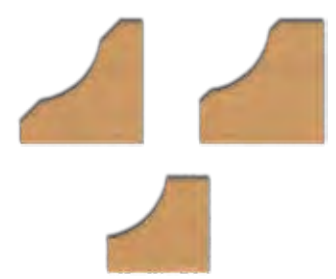
Types of profiles FR98H

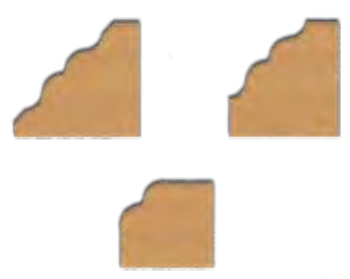
 <p>9841004 9841006</p>	<p>With straight blade cod. 9841004</p> 	 <p>9841013 R20/90°</p> 
 <p>9841005 1/4 R10 1/4 R15 1/4 R5</p>	<p>R:5 R:10</p> 	 <p>9841014 R10 R10</p> 
 <p>9841010 1/4 R25</p>		 <p>9841015 R5/180° R20/180° R5/180°</p> 
 <p>9841011 1/2 R4 1/2 R7 1/2 R5</p>	<p>R:5 R:7 R:4</p> 	 <p>9841016 R:-20</p> 
 <p>9841012 R25</p>		 <p>9841017 R:-7 R:7 R:-7</p> 

Blades dimension reduced at 75%
Profiles dimension reduced at 25%



CE53S | Edge lipping planer

Special purpose planer for flushing works in the manufacture of furnitures. It is ideal for flushing strips on edges. Provided with a large support surface to allow easy and safe operation. The tool cuts accurately and is easily adjustable. The support base is height-adjustable with respect to the cutting plane of the cutter-holder. Thanks to its high power rating (1,300 W) it can be operated without risk of mechanical fatigue. It is provided with replaceable reversible carbide blades which do not require adjustment and dust collector connection.



Precise easily adjusted cut.



Dust collector connection.



Working on solid surface material (i.e. Corian®).

Optional accessories

- 6446073 Standard dust collector attachment 2.25 m
- 1746245 Standard dust collector attachment 5 m

Blades

- 5346072 Set of 2 carbide reversible blades
- 5399059 Reversible blades holder

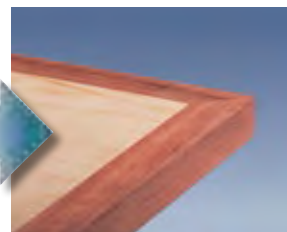

The CE53S is very effective for flushing straight or rounded corners.



Accurate cut, easy adjustable.

Flushing works on wooden or solid surface materials are very accurate, allowing to have a perfect integration of surface together with the strips or edges.

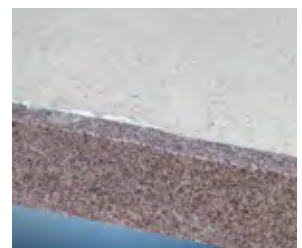

Perfect finishing on solid surface material.

Specifications

Input power	1,300 W
Cutting width	55 mm
Cutting depth	5-0 mm
No-load speed	10,000/min
Blade-holder brake system	
Weight	6.5 kg





CE96H | Curved planer

Professional planer for convex or concave surfaces, with the possibility of working on flat surfaces. Ideal for shipyards, carpentry and any other application requiring curved planing. It is light weight and therefore useful for work in and out of the workshop. Includes replaceable reversible carbide blades which do not require adjustment and dust collector connection.



Planing concave surfaces.



Planing convex surfaces.



Maintenance work in shipyards.

With carrying case



Optional accessories

Rustic "adze" finishing blades

2031086 Set 2 HSS convex blades with supports.

2031087 Set 2 HSS concave blades



Optional accessories

6446073 Standard dust collector attachment 2.25 m

1746245 Standard dust collector attachment 5 m

Blades

3540118 Set 2 carbide reversible blades

3531019 Set 2 HSS reversible blades

3599101 Reversible blades holder



Rustic finishing.

Rustic "adze" finishing

Ideal to obtain in a easy and simple way a rustic finishing on wooden beams, columns, panels and some other wooden surface. Thanks to the machine adjustment it is possible to obtain different finishings, depending on the cutting depth adjustment.



Specifications

Input power	700 W
Cutting width	80 mm
Cutting depth	0-3 mm
Minimum concave radius	450 mm
Minimum convex radius	400 mm
No-load speed	16,500/min
Weight	3.2 kg



Video



CE223X | DUO planer

The DUO planer is a total new concept. Equipped with interchangeable tool holders for helicoidal blade and sanding roller.

Easy to adapt to the wanted finishing, just changing the tool holder with helicoidal blade or sanding roller in few minutes.

The tool holder with helicoidal blade provides a high quality planing without traces and less noise, thanks to the oblique cutting.

The abrasive roller can be used for sanding several kind of materials: wood and its products, solid surface materials, synthetic materials, stripping paints on flat surfaces... Adjustable rear shoe regarding the cutting line of the tool holder.

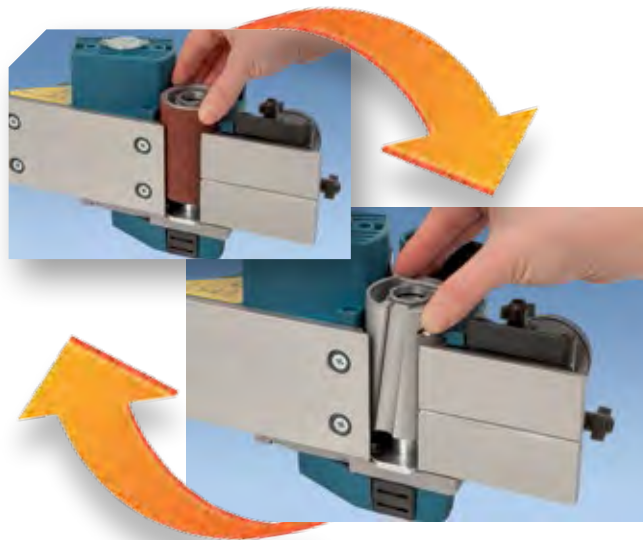

Its versatility makes it to be able to adapt to several kind of jobs just only changing the tool holder. With the sanding roller, it is possible to plane doors or shelves without risk to splinter them.

Standard equipment

Tool holder with helicoidal blade, tool holder for abrasive roller with abrasive roller Gr. 40, lateral fence, carrying case and dust collection nozzle.



The CE223X DUO can be adapted to several kind of surfaces thanks to its dual system.



There are several applications using the sanding roller.

For example: sanding wooden repairing splines, planing panels made up with several layers of different materials, like insulating modules, repairing of surfboards, boats...

Optional accessories

2346558 Tool holder for straight reversible blades.

6446073 Dust collector attachment 2.25 m.

1746245 Dust collector attachment 5 m.



Specifications

Input power	700 W
Cutting width	80 mm
Cutting depth	0-3 mm
Max. rabbeting depth	11 mm
No-load speed	16,500/min
Max. sanding depth	0 - 1 mm
Sanding roller width	81 mm
Weight	3.2 kg



Optional sanding rollers

- 2345510 Roller g. 40 Carborundum
 - 2345511 Roller g. 50 Carborundum
 - 2345512 Roller g. 60 Carborundum
 - 2345514 Roller g. 60 (Zirconium Oxide)*
- (*) for hard materials



Video



CE23N | Abrasive planer

Highly useful, fast and effective for delicate jobs in wood, also in sanding and stripping paints, varnishes and resins, particularly on large flat surfaces. It allows sanding and shaving with a superb finishing, even on delicate or brittle materials they can be damaged or splintered by a standard planer. Equipped with dust collection nozzle.



It allows to plane shelves or doors without splintering or damaging the edges.



Ideal for stripping paints or varnishes on doors or other flat surfaces.



Standard equipment

Carrying case and sanding roller gr. 50 Carborundum.

Optional accessories

- 3546021 Lateral fence
- 6446073 Standard dust collector attachment 2.25 m
- 1746245 Standard dust collector attachment 5 m

CE123N | Curved abrasive planer

Similar to the CE23N model, but with an adjustable curved base for concave, convex and flat surfaces. Specially useful for working in shipyards, where resins with fiberglass, carbon fibre and kevlar are used. Also for stripping layers of gel coat and paint. Minimum concave radius 450 mm. Maximum convex radius 400 mm. Equipped with dust collection nozzle.



Sanding on materials with several layers of different materials with different hardness and texture.



Standard equipment

Carrying case and sanding roller gr. 50 Carborundum.

Optional accessories

- 3546021 Lateral fence
- 6446073 Standard dust collector attachment 2.25 m
- 1746245 Standard dust collector attachment 5 m



Adjustable to curved surfaces. Specially useful in shipyards.



Sanding rollers for CE23N and CE123N

Abrasive rollers are easy to replace, with no tools required.

Sanding rollers (optional)

- 2345510 Roller g. 40 Carborundum
 - 2345511 Roller g. 50 Carborundum
 - 2345512 Roller g. 60 Carborundum
 - 2345514 Roller g. 60 (Zirconium Oxide)*
- (*) For hard materials.



Specifications

Input power	700 W
No-load speed	16,500/min
Sanding depth per pass	0-1 mm
Roller width	81 mm
Weight	3.2 kg



Specifications

Input power	700 W
No-load speed	16,500/min
Sanding depth per pass	0-1 mm
Roller width	81 mm
Weight	3.2 kg





LB31E/LB31EA | Belt sanders

Top performance belt sander for levelling and rough work. Its large sanding surface increases productivity and ensures the obtention of a scratchless finish. It is provided with tungsten carbide stoppers to prevent housing wear caused by belt operation. Equipped with a dust collector connection to allow the operator to work comfortably and cleanly. Model LB31EA equipped with built-in dust collector.



Large sanding surface.



External dust collector connection on model LB31E.



Mod. LB31EA includes built-in dust collector.

Optional accessories

- 3300071 Dust collector for LB31E
- 6446073 Standard dust collector attachment 2.25 m
- 1746245 Standard dust collector attachment 5 m

Sanding belts
see pag. 23



AF11 | Belt sander

This is a high performance belt sander for roughing and flushing. Its large sanding surface increases productivity and ensures the obtention of a scratchless finish. Its three-phase, 900 W motor, allows it to perform heavy work without maintenance problems. It is provided with tungsten carbide stoppers to prevent housing wear caused by belt operation. Equipped with a dust collector connection to allow the operator to work comfortably and cleanly.



Uniform sanding without grooves.



External dust collector connection.

Optional accessories

- 6446073 Standard dust collector attachment 2.25 m
- 1746245 Standard dust collector attachment 5 m

Sanding belts
see pag. 23



Specifications

Input power	1,200 W
Belt size	690x100 mm
Working surface	175x100 mm
Belt speed	420 m/min
Weight	6.5 kg



Specifications

Input power	900 W
Voltage (3-phase)	220/380 V
Belt size	690x100 mm
Working surface	175x100 mm
Belt speed	327 m/min
Weight	9.7 kg





LR46L | Orbital sander

High performance orbital sander for polishing and finishing. Powerful and well balanced, it allows the user to carry out high quality work without the need for touching up. The PUR plate which comes as standard is virtually unbreakable. This machine has a new dust protection system and integral dust collection that makes abrasives last longer. The ergonomic design with anti-slip surfaces and frontal handle makes the machine comfortable and efficient to work with. Standard abrasives can be used.



High quality finishes, without touching up.



Mobile base for use with velcro sandpapers.

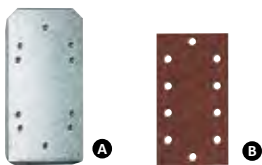

Optional accessories
 8646132 Centering device for sanding paper **A**
 6446073 Standard dust collector attachment 2.25 m

Sanding sheets
 see pag. 23 **B**

LRE46L | Electronic orbital sander

High performance electronic orbital sander for polishing and finishing. Similar specifications to model LR46L but including electronic speed control. The PUR plate which comes as standard is virtually unbreakable. This machine has a new dust protection system and integral dust collection. The ergonomic design with anti-slip surfaces and frontal handle make the machine comfortable and efficient to work with. Standard abrasives can be used.



High quality finishes, without touching up.



Mobile base for use with velcro sandpapers.

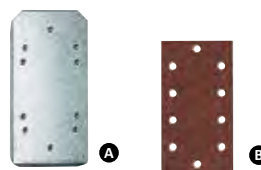

Optional accessories
 8646132 Centering device for sanding paper **A**
 6446073 Standard dust collector attachment 2.25 m

Sanding sheets
 see pag. 23 **B**



Electronic speed control.

Specifications

Input power	370 W
Orbit diameter	2 mm
Pad size	115x208 mm
No-load speed	10,000/min
Strokes	20,000/min
Weight	3 kg



Specifications

Input power	370 W
Orbit diameter	2 mm
Pad size	115x208 mm
No-load speed	4,000-9,800/min
Strokes	8,000-19,600/min
Weight	3 kg





LR284R | Light orbital sander

Light and powerful sander for sanding any kind of surfaces. Its ergonomic design allows a perfect holding and a smaller fatigue, thanks to its perfect balancing, reducing the vibrations level for the user.

Equipped with a big long life polyurethane sanding base allowing to sand near the corners or edges without damaging or scratching. This feature avoids the metal parts can be in contact with mouldings or other elements.

The base dimension, 93x185 mm, makes it ideal for sanding narrow surfaces, between mouldings or other elements on both sides. Integrated dust collection.



Strong aluminium base.



High quality finishing on several kind of surfaces.



Optional accessory (8499219) for velcro sanding papers.

Optional accessories

- 8499219 Accessory for velcro sanding papers
- 8445571 Centering device
- 6446073 Standard dust collector connection 2.25 m

Sanding sheets
see pag. 23

LR84H/LRE84H | Mini-orbital sanders

Light and powerful mini-orbital sander for polishing and finishing. Its ergonomic design makes it less tiring to use and the controls more easily accessible. Includes an extra base with a delta shape for velcro sanding sheets, making it ideal for sanding difficult to reach surfaces such as frames, blinds, etc. Integrated dust collection. Can be converted into a rotary orbital sander by using the optional disc.



Ideal for sanding and finishing frames and other surfaces.

The LRE84H model has electronic speed control, which allows you to choose the most suitable speed to the material.



Using the delta base interior corners are quick and easy to sand.

Sanding sheets
see pag. 23



Optional accessories

- 8499211 Accessory for velcro sanding papers
- 8445598 Velcro rotary orbital disc **A**
- 8445232 Centering device **B**
- 6446073 Standard dust collector attachment 2.25 m



Sanding difficult to reach areas such as blinds, etc...

Specifications

Input power	180 W
Orbit diameter	2 mm
Pad size	93x185 mm
No-load speed	12,500/min
Strokes	25,000/min
Weight	1.5 kg



Specifications

Input power	180 W
Orbit diameter	2 mm
Pad size	80x130 mm
No-load speed	LR84H 12.500/min - LRE84H 7,000-12,500/min
Strokes	LR84H 25.000/min - LRE84H 14,000-25,000/min
Weight	1.5 kg





LRT84H | Electronic multi sander

Multi sander LRT84H, orbital and rotary orbital, in one machine. Its ergonomic design makes it less tiring to use and the controls more easily accessible. Like orbital sander it includes an extra base with a delta shape for velcro sanding sheets, making it ideal for sanding difficult to reach surfaces such as frames, blinds etc. Like rotary orbital it combines two movements (rotary and orbital) leaving totally smooth mark-free surfaces. It includes a disc for velcro sanding discs. Electronic speed control to choose the most suitable speed for the material. Brake system for the disc to prevent over-acceleration when not loaded. Integrated dust collection.



Using the delta base interior corners are quick and easy to sand.



Like rotary orbital it combines two movements: rotary and orbital.



Optionally it can be delivered with carrying case.



A

Optional accessories

- 8445232 Centering device **A**
- 6446073 Standard dust collector attachment 2.25 m

Sanding sheets & discs

see pag. 23

RTE84H | Mini rotary orbital sander

Mini rotary orbital sander for high quality polishing and finishing. Light but powerful making ideal for working on any surface. It combines two movements (rotary and orbital) leaving totally smooth mark-free surfaces. Ideal for delicate work, varnishing etc. It can also carry out high speed abrasion. Its ergonomic design makes it less tiring to use and the controls more easily accessible. Includes a base for velcro sanding discs and electronic speed control to choose the most suitable speed for material. Brake system for the disc to prevent over-acceleration when not loaded. Integrated dust collection.



The worked surfaces are left totally smooth and mark-free.



Dust collection holes designed to fit the majority of standard velcro sanding discs.



Electronic speed control.

Sanding discs

see pag. 23

Optional accessories

- 6446073 Standard dust collector attachment 2.25 m
- 1746245 Standard dust collector attachment 5 m

Specifications

Input power	180 W
Orbit diameter	2 mm
Pad size	80x130 mm
Disc diameter	125 mm
No-load speed	7,000-12,500/min
Strokes	14,000-25,000/min
Weight	1.5 kg



Specifications

Input power	180 W
Orbit diameter	2 mm
Disc diameter	125 mm
No-load speed	7,000-12,500/min
Strokes	14,000-25,000/min
Weight	1.4 kg





RTE146L / RTE46L | Rotary orbital sanders

High performance rotary orbital sanders for high quality polishing and finishing, ideal in situations where the surface is to be varnished or enamelled. Combines both rotary and orbital movements, leaving surfaces smooth and mark free. Planing jobs are completed quickly. These sanders have a new dust-protection system and integral dust collection, allowing the use of standard abrasives and plates. The ergonomic design with anti-slip surfaces makes the machines comfortable and efficient to work with. Electronic speed control and disc braking system, preventing no-load over-acceleration.



High quality finishing.

Available with two kinds of orbit:
 Model RTE146L, 4 mm orbit, for fine and extrafine sanding jobs, ideal for surfaces to be enamelled.
 Model RTE46L, 7 mm orbit, for medium to finegrade sanding jobs, with a greater capacity for rectification.



Dust collection holes designed to fit the majority of standard sanding discs.

Standard sanding pad
 4645093 Hard sanding pad
 Ø 150 mm (velcro)



Optional accessories
 6446073 Standard dust collector attachment 2.25 m

Sanding discs
 see pag. 23



Total protection against the sanding dust

The models RTE46L, RTE146L, RT188N, LR46L & LRE46L are equipped with a new and efficient "airtight" protection system against the dust avoiding it to go into the ball bearings and to damage them.

Easy change of sanding pad without tools thanks to the lock button.



Both models are equipped with electronic speed control to choose the most suitable speed for the material to be sanded.

Specifications

Input power	350 W
Orbit diameter RTE146L	4 mm
Orbit diameter RTE46L	7 mm
Disc diameter	150 mm
No-load speed	4,000-8,000/min
Weight	2.6 kg





RT188N | Rotary orbital sander

Ideal for sanding or polishing wooden or metal surfaces it is equipped with a powerful motor of 900 W with electronic speed adjustment. It is the most powerful rotary orbital sander in the market. Their big power and well balanced design allow a perfect sanding work with a low level of vibrations.

The 7 mm orbit gives a high quality sanding and cobinated with the rotary orbital movement leave the surfaces smooth and mark free ready for vernishing or painting. The electronic speed adjustment allows to adjust the speed to the material to be sanded under the most ideal conditions.

Powerful dust collection.



High quality finishing.



Dust collection holes designed to fit the majorit of standard sanding discs.

PDE446L | Disc sander

Specially designed for sheet metal and marble sanding work. Its powerful 700 W motor provides the heavy duty sturdiness required for heavy work without fatigue. Standard equipment includes a rubber disc and sanding disc. Equipped with electronic speed control.



Ideal for sheet steel work.

Sanding discs: see pag. 23



Sanding marble.

Sanding discs

see pag. 23

Optional accessories

6446073 Standard dust collector attachment 2.25 m

1746245 Standard dust collector attachment 5 m

Specifications

Input power	900 W
Orbit diameter	7 mm
Disc diameter	150 mm
No-load speed	3,500-7,500/min
Weight	2.6 kg



Specifications

Input power	700 W
Disc diameter	173 mm
No-load speed	2,000-3,800/min
Weight	3 kg





LPC97S | Long-reach drywall sander

Ideal for painter and decorators for sanding walls and ceilings. It allows to work easier, faster and less tiring. Ergonomic and strong design. Easy to use and light weight. Well balanced machine guiding allowing to sand in several angles in an easy way. The motor placed in the upper position, near the sanding disc, makes the machine very handy and allows to work on walls and ceilings with total control.

Big sanding capacity. Electronic speed control to choose the most suitable speed for the surface to be sanded and the sanding paper. Switch protected against the dust and distant from the sanding area. Dust collection nozzle with fast bayonet connector. Dust collection pipe (4 m) and carrying bag included as standard equipment.



Strong sanding plate with velcro system.



High sanding capacity for sanding stuccoed walls.



Dust collection pipe can be easily connected thanks to the bayonet connector.

Standard equipment

Dust collection pipe (4 m), velcro strips for fixing the cord to the pipe, complementary handle, sanding disc gr. 80, carrying bag and service key.

LPM97S | Hand-held drywall sander

Ideal for painter and decorators for sanding walls and ceilings. It allows to work easier, faster and less tiring. Big sanding capacity. Electronic speed control to choose the most suitable speed for the surface to be sanded and the sanding paper. Dust collection nozzle with fast bayonet connector. Carrying box included.



Possibility to disassemble the frontal part of the sanding head for working on corners.



It allows to sand the walls even in difficult areas.

Optional accessories

For models LPC97S and LPM97S
8200100 AS182K Dust collector 27 l.
8200200 AS282K Dust collector 72 l.
9702697 Velcro strips to fix the cable to the pipe (included as standard with LPC97S)
9745948 Velcro disc (spare)

Sanding discs
see pag. 23



Carrying case

Specifications

Input power	550 W
No-load speed	650-1,600 rpm
Ø sanding disc	225 mm
Total length	1,520 mm
Weight	3.6 kg



Specifications

Input power	1,200 W
No-load speed	650-1,300 rpm
Ø sanding disc	225 mm
Weight	3.1 kg





ST62 | Brush sander

High performance machine designed for satin, polish and ageing of different surfaces. Allows to extract paints on wooden pieces. It also eliminates scratches and burrs in metals. To do this Virutex has a range of different brushes for the different applications. Equipped with a powerful motor of 1,400 W protected against the dust. Precise operation and electronic soft start. Electronic speed adjustment. Equipped with double reduction gear. Adjustable guiding system for an easy and safe work. External dust collector attachment.



For satin, polish and ageing several kind of surfaces.



Standard equipment

Nylon roller (ref. 6291214), top handle, service key and stackable carrying case.

Optional brushes:

For working on wood, metal or stone surfaces

1. Nylon brush Ref. 6291214: For ageing wood, satin or polish marble or metals
2. Metal brush Ref. 6291215: For ageing wooden surfaces. For removing rust, paint and burrs in metals.
3. Abrasive roller Ref. 6291216: To smooth wooden surfaces and remove scratches on metals.
4. Abrasive roller Ref. 6291217: To smooth wooden surfaces and to satin and polish inox steel and other metals.

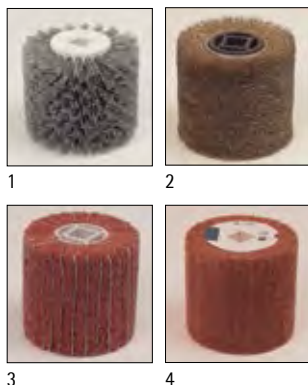

RO156N | Straight grinder

Auxiliary straight grinder, equipped with 6 mm chuck collet, for metal finishings and roughdressings. It can be used with most standard grinding accessories on the market. Electronic speed control.



It allows to make finishings and roughdressings in metals. (Grinding tool not included)

Optional collets

- 1222085 Chuck collet Ø 6.35 mm (1/4")
- 1222024 Chuck collet Ø 8 mm



Specifications

Input power	1,400 W
No-load speed	1,000 - 4,000/min
Brush diameter	110x100x19 mm
Weight	3.6 kg



Specifications

Input power	750 W
No-load speed	14,000-30,000/min
Standard collet capacity	8 mm
Max. wheels Ø 40m/s.	25 mm
Spindle flange diameter	43 mm
Weight	1.3 kg



Sanding belts



Ref.	Description	Models
4491022	10 Belts 690x100 Gr. 30	LB31E, LB31EA, AF11
4491006	10 Belts 690x100 Gr. 40	LB31E, LB31EA, AF11
4491007	10 Belts 690x100 Gr. 50	LB31E, LB31EA, AF11
4491008	10 Belts 690x100 Gr. 60	LB31E, LB31EA, AF11
4491009	10 Belts 690x100 Gr. 80	LB31E, LB31EA, AF11
4491010	10 Belts 690x100 Gr. 100	LB31E, LB31EA, AF11

Sandpaper sheets



Ref.	Description	Models
6791213	8 Sheets Gr. 80 (c)	LR46L, LRE46L
6791214	8 Sheets Gr. 120 (c)	LR46L, LRE46L
6791215	8 Sheets Gr. 150 (c)	LR46L, LRE46L
4691216	8 Sheets Gr. 100 (c)	LR46L, LRE46L
8691217	8 Sheets Gr. 60 115x208 c/velcro (c)	LR46L, LRE46L
8691218	8 Sheets Gr. 80 115x208 c/velcro (c)	LR46L, LRE46L
8691219	8 Sheets Gr. 120 115x208 c/velcro (c)	LR46L, LRE46L
8691220	8 Sheets Gr. 150 115x208 c/velcro (c)	LR46L, LRE46L
9391221	8 Sheets Gr. 60 (c)	LR84H, LRE84H, LRT84H
9391222	8 Sheets Gr. 80 (c)	LR84H, LRE84H, LRT84H
9391223	8 Sheets Gr. 120 (c)	LR84H, LRE84H, LRT84H
9391224	8 Sheets Gr. 150 (c)	LR84H, LRE84H, LRT84H
8491225	8 Sheets Gr. 100	LR84H, LRE84H, LRT84H
8491226	8 Sheets Gr. 40 81x132 velcro	LR84H, LRE84H, LRT84H
9391227	8 Sheets Gr. 60 81x132 velcro	LR84H, LRE84H, LRT84H
9391228	8 Sheets Gr. 80 81x132 velcro	LR84H, LRE84H, LRT84H
9391229	8 Sheets Gr. 120 81x132 velcro	LR84H, LRE84H, LRT84H
9391230	8 Sheets Gr. 150 81x132 velcro	LR84H, LRE84H, LRT84H
8491231	8 Sheets Gr. 220 81x132 velcro	LR84H, LRE84H, LRT84H
8491232	8 Sheets Gr. 400 81x132 velcro	LR84H, LRE84H, LRT84H
8491233	8 Sheets Gr. 50 93x230	LR284R
8491234	8 Sheets Gr. 80 93x230	LR284R
8491235	8 Sheets Gr. 120 93x230	LR284R
8491236	8 Sheets Gr. 150 93x230	LR284R
8491237	8 Sheets Gr. 100 93x230	LR284R
8491238	8 Sheets Gr. 40 93x185 velcro	LR284R
8491239	8 Sheets Gr. 60 93x185 velcro	LR284R
8491240	8 Sheets Gr. 80 93x185 velcro	LR284R
8491241	8 Sheets Gr. 120 93x185 velcro	LR284R
8491242	8 Sheets Gr. 150 93x185 velcro	LR284R
8491243	8 Sheets Gr. 220 93x185 velcro	LR284R
8491244	8 Sheets Gr. 400 93x185 velcro	LR284R

All sandpaper sheets have dust collection holes.

Delta sandpapers



Ref.	Description	Models
8491245	8 Delta sandpaper Gr. 40 velcro	LR84H, LRE84H, LRT84H
8491246	8 Delta sandpaper Gr. 60 velcro	LR84H, LRE84H, LRT84H
8491247	8 Delta sandpaper Gr. 80 velcro	LR84H, LRE84H, LRT84H
8491248	8 Delta sandpaper Gr. 120 velcro	LR84H, LRE84H, LRT84H
8491249	8 Delta sandpaper Gr. 220 velcro	LR84H, LRE84H, LRT84H
8491250	8 Delta sandpaper Gr. 400 velcro	LR84H, LRE84H, LRT84H

All delta sandpapers have dust collection holes.

Sanding discs



Ref.	Description	Models
4691251	8 Discs Gr. 40 (Ø150) velcro	RTE46/146L, RT188N
4691252	8 Discs Gr. 60 (Ø150) velcro	RTE46/146L, RT188N
4691253	8 Discs Gr. 80 (Ø150) velcro	RTE46/146L, RT188N
4691254	8 Discs Gr. 120 (Ø150) velcro	RTE46/146L, RT188N
4691255	8 Discs Gr. 150 (Ø150) velcro	RTE46/146L, RT188N
4691256	8 Discs Gr. 220 (Ø150) velcro	RTE46/146L, RT188N
4691257	8 Discs Gr. 320 (Ø150) velcro	RTE46/146L, RT188N
8491258	8 Discs Gr. 40 (Ø 125) velcro	RTE84H, LRT84H
8491259	8 Discs Gr. 60 (Ø 125) velcro	RTE84H, LRT84H
8491260	8 Discs Gr. 80 (Ø 125) velcro	RTE84H, LRT84H
8491261	8 Discs Gr. 120 (Ø 125) velcro	RTE84H, LRT84H
8491262	8 Discs Gr. 220 (Ø 125) velcro	RTE84H, LRT84H
8491263	8 Discs Gr. 400 (Ø 125) velcro	RTE84H, LRT84H

All sanding discs have dust collection holes.

Sanding disc for PDE446L



Ref.	Description	Models
4591020	1 Sanding disc Gr. 120 (without dust collection holes)	PDE446L

Sanding discs for LPC97S & LPM97S

Ref.	Description	Models
9791114	Cement, rough surfaces, wallpaper Gr.24 (10 u.)	LPC97S, LPM97S
9791115	Filler, paint, rough sanding Gr.40 (25 u.)	LPC97S, LPM97S
9791116	Filler, paint, rough sanding Gr.60 (25 u.)	LPC97S, LPM97S
9791117	Filler, paint, rough sanding Gr.80 (25 u.)	LPC97S, LPM97S
9791118	Filler, paint, rough sanding Gr.100 (25 u.)	LPC97S, LPM97S
9791119	Filler, paint, rough sanding Gr.120 (25 u.)	LPC97S, LPM97S
9791120	Filler, paint, rough sanding Gr.150 (25 u.)	LPC97S, LPM97S
9791121	Filler, paint, rough sanding Gr.180 (25 u.)	LPC97S, LPM97S
9791122	Filler, paint, rough sanding Gr.220 (25 u.)	LPC97S, LPM97S

The sanding discs marked with (c) are only recommended for woodworking and the rest for woodworking and sanding metals.

Hard pads for rotary orbital sanders



Ref.	Description	Models
4645093	Pad Ø 150 mm (velcro)	RTE46L, RTE146L
8846367	Pad Ø 150 mm (adhesive)	RT188N
8846366	Pad Ø 150 mm (velcro)	RT188N
8445598	Pad Ø 125 mm (velcro)	LR84H, LRE84H, LRT84H, RTE84H

Soft pads for rotary orbital sanders

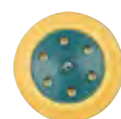

Ref.	Description	Models
4745040	Soft pad Ø 150 mm (adhesive)	RTE46L, RTE146L
4745092	Soft pad Ø 150 mm (velcro)	RTE46L, RTE146L
8845485	Soft pad Ø 150 mm (velcro)	RT188N
8845487	Soft pad Ø 150 mm (adhesive)	RT188N



FR192VG | Electronic trimmer

Light weight designed for several kind of jobs. Provides excellent finishing on laminate trimming. Possibility to make right or circular slots in an easy and precise way with the accessories included as standard equipment.

Standard equipment

Carbide flush/bevel bit, lateral fence, guide ring and service keys.

Optional accessories

1222024 Chuck collet 8 mm
 1222085 Chuck collet 6.35 mm (1/4")
 1240046 Rabbeting bit
 Templates for fitting hinges (see page 62)
 Clamping systems (see page 90)

Guide rings

1250001 Ø ext. 10 mm for 6 mm bits
 1250002 Ø ext. 12 mm for 8 mm bits
 1250003 Ø ext. 14 mm for 10 mm bits
 1250004 Ø ext. 16 mm for 12 mm bits
 1250025 Ø ext. 18 mm for 14 mm bits
 1250035 Ø ext. 20 mm for 16 mm bits



Excellent finishing when trimming laminates.



Trimming rabbet with optional bit 1240046 (and sliding shoes ref. 1250041 or 1850042)



Making mouldings.

Equipped with electronic speed control and electronic system which maintains the speed constant independently to the working load.



Trimming circular slots.



Trimming parallel slots.

Optional accessories

- 45° sliding shoe Ref.1850042
- Flat sliding shoe Ref.1250041
- Sliding shoe Ref. 1250040
- Flat sliding shoe 25 mm Ref. 1250078

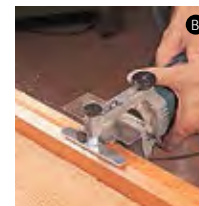

Bits
 see pag. 48

Specifications

Input power	1,000 W
Max. bit diameter	25 mm
Chuck collet	6 mm
No-load speed	14,000-30,000/min
Weight	1.8 kg



Optional
 Trimming head for fitting hinges ZB93 (ref. 1750000).





FR292R | Electronic tiltable trimmer

The only trimmer capable of trimming the excess of the panel or edge surfaces flat or at any angle, without changing the bit.

Its wide base provides effective guiding and easy trimming. It offers numerous additional trimming possibilities, thanks to the unique tilting and adjustment system.

Equipped with a powerful 750 W motor with electronic speed adjustment and constant torque control for a constant motor speed under load. External dust collector connection.

Standard equipment

Carbide 90° bit (1140087) and straight bit Ø 18 mm (1140016) for trimming and grooving. Chuck collet Ø 8 mm, copier with ball bearing, lateral fence with compass, service keys and carrying case.

Optional accessories

6446073 Standard dust collector attachment 2.25 m
 1746245 Standard dust collector attachment 5 m
 1222084 Chuck collet 6 mm
 1222085 Chuck collet 6,35 mm (1/4")
 Guide rings (see page 61 model FR129N)
 Clamping systems (see page 90)



Lateral fence, avoids the irregularities of the edges can be copied.



Copier with ball bearing. Perfect guiding on straight or curved surfaces.



Guide ring for copying with template as a small router.

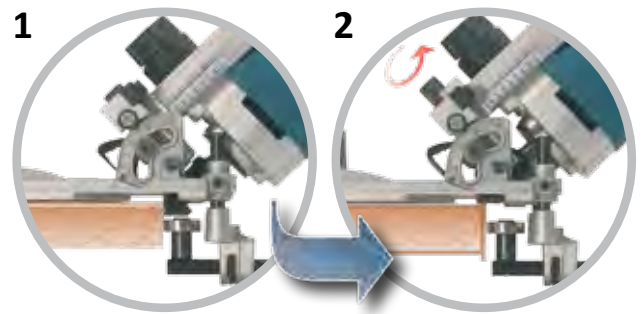

Easier, more accurate trimming, with the special 90° bit.

The machine body can be tilted to approximately 46.5°, so that the edge of the bit is at 1.5° to the surface, preventing damage when trimming excess edges. Once the excess coating has been trimmed from the board surface (1), just position the bit at the level of the base to trim the excess edge level with the surface (2). By simply operating a single adjustment

control, you can trim a further excess surface or edge.

By tilting the machine to the horizontal position, you can trim 45° chamfered edges. You can also chamfer to the angle you require (A°) between 0° and 45°, by tilting the motor body to the required intermediate angle (45° + A° on the machine indicator).

Trimming with the straight bit

The tiltable motor body permits the trimming of straight edges with the straight bit (included as standard equipment) as well as the excess surface. Excess panel is trimmed with the motor body in the vertical position, and edges with the motor body inclined to 91.5°, i.e. at 1.5° below the board surface, thereby avoiding damage.



Trimming the edge with the straight bit.

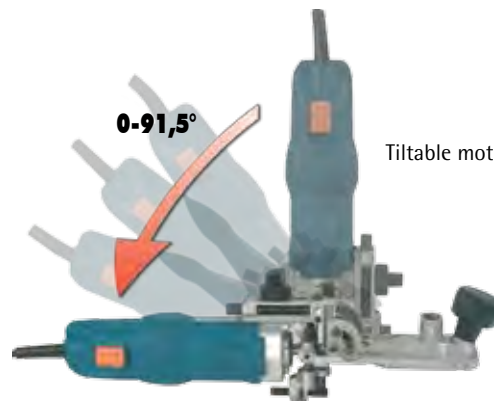

Tiltable motor from 0° to 91.5°.

Bits
see pag. 48

Some examples of trimming

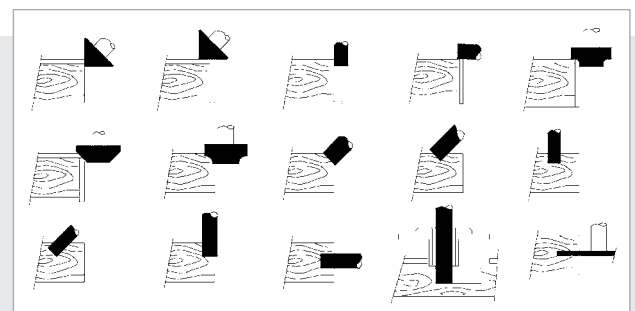

Specifications

Input power	750 W
Max. bit diameter	25 mm
Chuck collet	8 mm
No-load speed	14,000-30,000/min
Weight	2.2 kg



FR156N | Edge trimmer

For trimming edges of PVC and veneer. Equipped with a carbide bit $r=3$ mm with bearing (1140106). Optional bits are available for several different radius. Powerful motor (750 W) and electronic speed adjustment. Also equipped with electronic control maintaining the speed constant, independently than the working load. Dust collector connection and three bases (hole \varnothing 20, 26 and 30 mm) for using with bits of different diameters.



Easy to use and excellent finishings.



It is possible to trim all sides of the panels with radius or a chamfer.



High quality finishing on corners.

Standard equipment

Carbide bit $r=2$ mm w/ bearing (1140123).



The new fine adjustment system makes it very easy to regulate the trimming head height.



The CA56U trimming head enables uninterrupted trimming of the four edges of a panel. It has a large support base and an auxiliary holding knob, designed to give it perfect stability.

Optional accessoires

- 1222084 Chuck collet 6 mm
- 1222085 Chuck collet 6.35 mm (1/4")
- 5600060 CA56U Trimming head



Special brake system for the ball bearing of the bit, avoiding that it can damage the panel when starting to work.

- 6446073 Standard dust collector attachment 2.25 m
- 1746245 Standard dust collector attachment 5 m
- 1140109 Carbide bit $r=6$ mm w/bearing
- 1140110 Carbide bit $r=8$ mm w/bearing
- 6399082 Cantspray



Perfect finishing in a few time.



Specifications

Input power	750 W
No-load speed	14,000-30,000/min
Chuck collet	8 mm
Weight	1.6 kg



Clamping systems (see page 90)



FR256N | Edge trimming set

This set includes the FR156N edge trimmer and the CA56U trimming head which allows to trim all the edges of the panel continuously. The CA56U trimming head has a large support surface and an auxiliary knob. Ideal for a trimming work on the panel edge.



Very easy trimming of either straight or shaped pieces.



Easy preparation for corner trimming



Precise guiding for corner trimming.



Vacuum connection equipped with a bearing brake to prevent leaving marks on the edge.



The new fine adjustment system makes it very easy to regulate trimming head height.



Round head (V3) included with the set. Very practical for trimming with support on edges and essential for jobs that require this type of work.



Standard equipment
FR156N Edge trimmer (with standard head), carbide bit r=2 mm with bearing (1140123), CA56U trimming head (5600060) and carrying case.

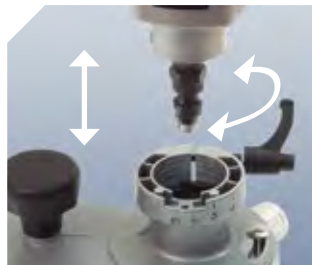

Simple adjustment of the height of the heads with the fine adjustment system.



The V3 head includes its own vacuum collector with a brake, and is also supplied with three sliding bases. (Holes d= 20, 26 and 30 mm).

Clamping systems (see page 90)

Specifications

Input power	750 W
No-load speed	14,000-30,000/min
Chuck collet	8 mm
Weight	2,2 kg



Optional accessoires

- 1222084 Chuck collet 6 mm
- 1222085 Chuck collet 6.35 mm (1/4")
- 6446073 Standard dust collector attachment 2.25 m
- 1746245 Standard dust collector attachment 5 m
- 1140106 HM bit r=3 mm with bearing
- 1140109 HM bit r=6 mm with bearing
- 1140110 HM bit r=8 mm with bearing
- 6399082 Cantspray





AS93 | Trimmer

Trimmer for laminate shaping. Its powerful 1,100 W motor makes it specially suited for heavy work. It can be easily converted into a surface router with the routing head CA66F for working with the PL11 template for dovetail joints or other routing works.



Trimming laminates.



Making mouldings.

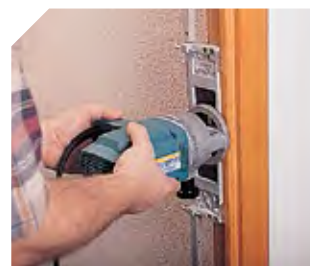

Fitting hinges with the CPN66 head.

Standard equipment

Flush/bevel carbide bit and service keys.

Optional accessories

6027056 Chuck collet 8 mm
6727020 Chuck collet 6.35 mm (1/4")
6600050 CA66F Routing head
6650088 CPN66 Hinge fitting head
Clamping systems (see page 90)
Templates for fitting hinges (see page 62)

Bits

see pag. 48

Guides rings

To be used with CA66F routing head

7722168 Ø ext. 10 mm (for 6 mm bits)
7722120 Ø ext. 12 mm (for 8 mm bits)
7722121 Ø ext. 14 mm (for 10 mm bits)
7722122 Ø ext. 16 mm (for 12 mm bits)
7722169 Ø ext. 18 mm (for 14 mm bits)
7722118 Ø ext. 20 mm (for 16 mm bits)
7722119 Ø ext. 27 mm (for 23 mm bits)
7722114 Ø ext. 30 mm (for 26 mm bits)
7722123 Guide for PL11 width 26 mm
7722161 Guide for PL11 width 16 mm
7722162 Guide for PL11 width 34 mm
7722160 Guide for AGB template
6640125 Bit for AGB template for bottom-hung fittings

Routing head CA66F (optional) to transform the AS93 into a router.



Specifications

Input power	1,100 W
Chuck collet	6 mm
No-load speed	23,000/min
Weight	3.7 kg





FR277R | Router

Surface routers for routing wood and plastic. Ideal for deburring edges, cutting out knots, copy routing, trimming, constructing frames and tooling, etc. Quick adjustment of routing depth with 3 pre-established positions. The model FR278R has a powerful 1,300 W motor and electronic speed control. External dust collection connector.



High precision and stability during routing.

FR278R | Electronic router



Model FR278R with electronic speed adjustment.



Quick adjustment of routing depth with 3 positions.

Standard equipment

Lateral fence, dust collector connection and service keys.

Optional accessories

(models FR277R & FR278R)

- 6446073 Standard dust collector attachment 2.25 m
- 1746245 Standard dust collector attachment 5 m
- 6045669 Compass guide
- 6045715 UC60 Universal compass guide
- 7722116 Reducer 6 mm
- 7722115 Reducer 6.35 mm (1/4")
- 7722161 Guide PL11 width 16 mm
- 7722123 Guide PL11 width 26 mm
- 7722162 Guide PL11 width 34 mm
- 7722160 Guide for AGB template
- 7722342 Guide for AGB template
- 7740117 Bit for AGB template for bottom-hung fittings
- Templates for fitting hinges (see page 62)
- Clamping systems (see page 90)
- 9045705 UC90P Cutting guide



Lever for blocking the routing head, accesible from the handle.



Lateral fence with micrometric adjustment.

Guide rings

(models FR277R & FR278R)

- 7722168 Ø ext. 10 mm for 6 mm bits
- 7722120 Ø ext. 12 mm for 8 mm bits
- 7722121 Ø ext. 14 mm for 10 mm bits
- 7722122 Ø ext. 16 mm for 12 mm bits
- 7722169 Ø ext. 18 mm for 14 mm bits
- 7722118 Ø ext. 20 mm for 16 mm bits
- 7722119 Ø ext. 27 mm for 23 mm bits
- 7722114 Ø ext. 30 mm for 26 mm bits

Bits
see pag. 48

Specifications

Input power	1,010 W
Chuck collet	8 mm
No-load speed	24,000/min
Routing depth	0-50 mm
Weight	2.9 kg



Specifications

Input power	1,300 W
Chuck collet	8 mm
No-load speed	6,000-27,000/min
Routing depth	0-50 mm
Weight	3 kg





FR66P | Router

Router for wood and plastic materials. High precision and stability when routing. Full control of the machine without releasing the handle. Rapid depth adjustment with three positions. Its powerful 1,300 W motor makes it specially suitable for hard, continuous jobs. Ideal for roughfacing edges, cutting knots, copy milling, dovetail assemblies (PL11 dovetailing attachment), making recesses for carpentry hardware, etc... Equipped with external dust collection connector.



Six adjustable depth positions for rapid selection of the desired routing depth.



On-Off switch and head blocking may be activated from the knob, giving total, safe control of the machine.



Total locking system for the routing depth, ideal for dovetailing assemblies and other jobs which require total locking of the headpiece.

Standard equipment

Lateral fence, dust collector connection, guide ring Ø 19 mm for dovetailing pitch plate 26 mm and service key.

Optional accessories

- 6045669 Compass guide
- 6045715 UC60 Universal compass guide (see pag. 37)
- 6027020 Chuck collet 6 mm
- 6727020 Chuck collet 6.35 mm (1/4")
- 6446073 Standard dust collector attachment 2.25 m
- 1746245 Standard dust collector attachment 5 m
- 6640125 Bit for AGB template for bottom-hung fittings
- Templates for fitting hinges (see page 62)
- 9045705 UC90P Cutting guide
- Clamping systems (see page 90)

Guide rings

- 7722168 Ext. Ø 10 mm (for 6 mm bits)
- 7722120 Ext. Ø 12 mm (for 8 mm bits)
- 7722121 Ext. Ø 14 mm (for 10 mm bits)
- 7722122 Ext. Ø 16 mm (for 12 mm bits)
- 7722169 Ext. Ø 18 mm (for 14 mm bits)
- 7722118 Ext. Ø 20 mm (for 16 mm bits)
- 7722119 Ext. Ø 27 mm (for 23 mm bits)
- 7722114 Ext. Ø 30 mm (for 26 mm bits)
- 7722161 Guide for PL11 width 16 mm
- 7722123 Guide for PL11 width 26 mm
- 7722162 Guide for PL11 width 34 mm
- 7722160 Guide for AGB template Ø 27 mm
- 7722342 Guide for AGB template Ø 21 mm



Supplied with lateral fence with micrometric adjustment and adjustable rules.

Bits

see pag. 48

Specifications

Input power	1,300 W
Chuck collet	8 mm
Routing depth	0-60 mm
No-load speed	26,000/min
Max. bit diameter	30 mm
Weight	3.8 kg



Double fence
6046397 (optional)



FR160P | Router

Professional routers for wood and plastic materials. High precision and stability when routing. Fast depth adjustment with 6 pre-adjusted positions. Their powerful motors (FR160: 1,500 W. FRE160P: 1,800 W) make them suitable for hard, continuous jobs. Ideal for trimming edges, cutting knots, copy milling, dovetail assemblies (with the optional PL11 dovetailing attachment), making recesses for carpentry hardware, etc... Equipped with fine adjustment of the routing depth and a lateral fence (delivered as standard equipment). Blocking system of the motor shaft for an easy change of bit. External dust collector connection for a clean and safe working area.

Optional accessories (models FR160P and FRE160P)

- 6045669 Compass guide
- 6045715 UC60 Universal compass guide
- 66446073 Standard dust collector attachment 2.25 m
- 1746245 Standard dust collector attachment 5 m
- 6040313 Bit for AGB template for bottom-hung fittings
- Templates for fitting hinges (see page 62)
- 9045705 UC90P Cutting guide
- Clamping systems (see page 90)



Micrometric adjustment of routing depth. 6 adjustable depth positions for rapid selection of the desired depth.



Supplied with lateral fence with micrometric adjustment and adjustable rules.

Standard equipment

Lateral fence, dust collector connection, guide ring Ø 19 mm for dovetailing pitch plate 26 mm and service key, reducer 8 mm and reducer 6 mm.

FRE160P | Electronic router



Total locking system for the routing depth, ideal for dovetailing and other jobs requiring total locking of the machine head.



Model FRE160P equipped with electronic speed control and electronic system which maintains the speed constant independently to the working load.

Guide rings (models FR160P and FRE160P)

- 7722168 Ext. Ø 10 mm (for 6 mm bits)
- 7722120 Ext. Ø 12 mm (for 8 mm bits)
- 7722121 Ext. Ø 14 mm (for 10 mm bits)
- 7722122 Ext. Ø 16 mm (for 12 mm bits)
- 7722169 Ext. Ø 18 mm (for 14 mm bits)
- 7722118 Ext. Ø 20 mm (for 16 mm bits)
- 7722119 Ext. Ø 27 mm (for 23 mm bits)
- 7722114 Ext. Ø 30 mm (for 26 mm bits)
- 7722161 Guide for PL11 width 16 mm
- 7722123 Guide for PL11 width 26 mm
- 7722162 Guide for PL11 width 34 mm
- 7722160 Guide for AGB template Ø 27 mm
- 7722342 Guide for AGB template Ø 21 mm

Specifications

Input power FR160P/FRE160P	1,500 W/1,800 W
Chuck collet	12 mm
Routing depth	0-60 mm
No-load speed FR160P	25,000/min
No-load speed FRE160P	11,500-23,000/min
Max. bit diameter	40 mm
Weight	5.4 kg



Double fence 6046397 (optional)

Bits
see pag. 48



FR356Z | Electronic router COMBI

The FR356Z is a convertible multifunction router using different routing and trimming heads. Includes as standard a routing head providing a high precision routing and stability. Equipped with fast depth adjustment with 6 positions and lateral fence with fine adjustment and adjustable guides.

Its ability "COMBI" allows it to couple to different types of heads and may also perform not only routing jobs, but also trimming jobs or grinding. The optional trimming heads are equipped with dust collector nozzle.

It is equipped with a powerful 1,000 W motor with electronic speed control and an electronic system to maintain constant speed under load.



Powerful motor (1,000 W). Equipped with electronic speed control as well as electronic power control that keeps the power constant even under load.



Micrometric adjustment of routing depth. 6 adjustable depth positions for rapid selection of the desired depth.



Supplied with lateral fence with micrometric adjustment and adjustable rules.

Standard equipment

Lateral fence, dust collector connection, guide ring Ø 19 mm for dovetailing pitch plate 26 mm and service key.

Bits

see pag. 48

Optional accessories (use as a router)

Accessories for routers: pages. 34 to 39

6046397 Double fence **A**

6446073 Standard dust collector attachment 2.25 m

1746245 Standard dust collector attachment 5 m

Templates for fitting hinges (see page 62)

Guide rings

7722168 Ext. Ø 10 mm (for 6 mm bits)

7722120 Ext. Ø 12 mm (for 8 mm bits)

7722121 Ext. Ø 14 mm (for 10 mm bits)

7722122 Ext. Ø 16 mm (for 12 mm bits)

7722169 Ext. Ø 18 mm (for 14 mm bits)

7722118 Ext. Ø 20 mm (for 16 mm bits)

7722119 Ext. Ø 27 mm (for 23 mm bits)

7722114 Ext. Ø 30 mm (for 26 mm bits)

7722161 Guide for PL11 width 16 mm

7722123 Guide for PL11 width 26 mm

7722162 Guide for PL11 width 34 mm



The COMBI router can be used with several heads:

It can work as a router, can be transformed into a trimmer and also as a straight grinder

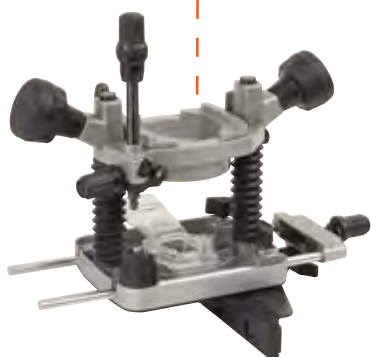

Routing head included as standard equipment

Routing head equipped with micrometric depth adjustment with 6 depth stoppers. Lateral fence equipped also with micrometric adjustment. With dust collection nozzle.



Trimming head with large support for straight or shaped panels. Brake for the bit bearing, avoiding that it can damage the panel when starting to work. Optional (5600060).



Round head for trimming on edge. Brake for the bit bearing, avoiding that it can damage the panel when starting to work. Optional (5646365).



Without any head can be used as a straight grinder.



Precise guide for corner trimming (ref. 5600060).

Trimming heads 5600060 and 5646365 are equipped with dust collection nozzle.

For finishing and sanding metals. (Grinding tool not included).

Optional accessories (use as a trimmer)

- 1222084 Chuck collet 6 mm
- 1222085 Chuck collet 6.35 mm (1/4")
- 6446073 Standard dust collector attachment 2.25 m
- 1140123 HM bit r=2 mm with bearing
- 1140106 HM bit r=3 mm with bearing
- 1140109 HM bit r=6 mm with bearing
- 1140110 HM bit r=8 mm with bearing
- 6399082 Cantspray



Specifications

Input power	1,000 W
No-load speed	14,000-27,000/min ⁻¹
Chuck collet	8 mm
Weight	3.8 kg



PL11 | Dovetailing attachment

Precision attachment for dovetail jointing. Equipped from factory with a dovetail template pitch 26 mm. Possibility to use other pitch dimensions with the additional kits. Fine adjustment of the dovetail beginning. Perfect dovetail joints.

Can be used with our routers models FR66P, FR160P, FRE160P, FR277R, FR278R and the trimmer AS93 with the CA66F routing head.



Start of dowel can be adjusted from both sides. High precision joints.



Can be secured to the workbench.



4 types of dovetail joints. Perfect finish on dovetail joints.

Standard equipment

Template pitch plate 26 mm

Optional accessories

- 6045710 Set of two clamp screws ^A
- 7745149 Dovetailing kit pitch plate 16 mm
- 7745150 Dovetailing kit pitch plate 34 mm
- 6040050 Dovetailing bit Ø 15 mm
- 1140060 Straight bit Ø 12 mm



As the machine is fully supported by the dovetailing attachment you can work with total stability, with no risk of damaging joints.



Specifications

Working width	360 mm
Pitch plate	26 mm
Optional pitch plates	16 or 34 mm
Minimum workpiece thickness	10 mm
Maximum workpiece thickness	30 mm
Weight	6.2 kg

Types of dovetailing

DOVETAIL PITCH 16 mm

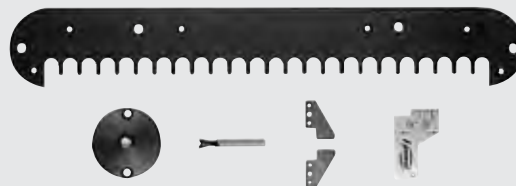
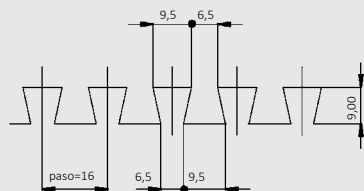

kit contents

Made with optional kit:
For FR66P, AS93 + CA66F, FR277R and FR278R: ref. 7745149

1 template pitch 16 mm, 1 guide ring/bit 12/9.5 mm, 1 dovetail bit HM Ø 9.5 mm, 2 guide stoppers and millimeter gauge.

DOVETAIL PITCH 26 mm

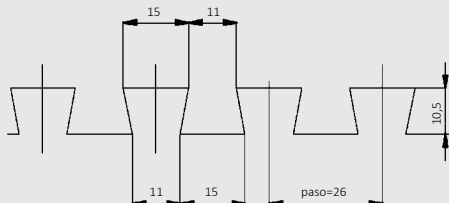

Dovetail bit Ø HM 15 mm
ref. 6040050
Guide ring ext. Ø 19 mm
For FR66P, AS93+CA66F, already included
For FR277R and FR278R ref. 7722123

Made with the template and stoppers included with the PL11 + bit + guide ring indicated below.

STRAIGHT JOINT PITCH 26 mm

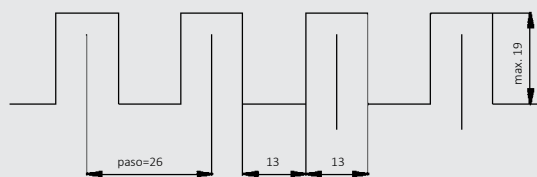
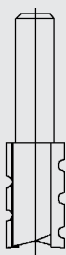

Straight bit Ø HM 13 mm
réf. 1140060
Guide ring ext. Ø 19 mm
For FR66P, AS93+CA66F, already included
For FR277R and FR278R ref. 7722123

Made with the template and stoppers included with the PL11 + bit + guide ring indicated below.

DOVETAIL PITCH 34 mm

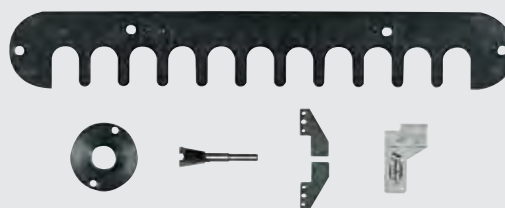
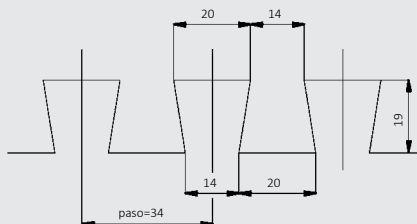
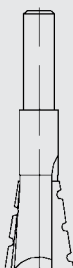

kit contents

Made with optional kit:
For FR66P, AS93 + CA66F, FR277R and FR278R: ref. 7745150

1 template pitch 34 mm, 1 guide ring/bit 23/20 mm, 1 dovetail bit HM Ø 20 mm, 2 guide stoppers and millimeter gauge.



Video



PFE60 | Template for trimming work tops

Precise and solid template manufactured in phenolic material 12 mm thick. Specially designed for trimming and assembling work tops from 420 mm to 650 mm width. The assembling angle can be 45° or 90°. It is also possible to trim radiuses for making the external round trimming. It is ideal to use with the routers model FR160P. Very easy to place and fix following the marked references on the template. Reduced trimming time, just about 15 minutes for the two sides of a work top.



Cross form trimming for jointing both sides of work top.

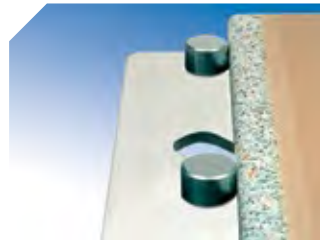

Steel stoppers.



Adjustable stopper for a correct positioning. It allows to correct the angle between the wall and the work top.



Minimum trimming time, just in about 15 minutes the trimming on both sides of the work top is made.

Standard equipment
Template for trimming work tops, 3 steel stoppers and adjustable stopper.

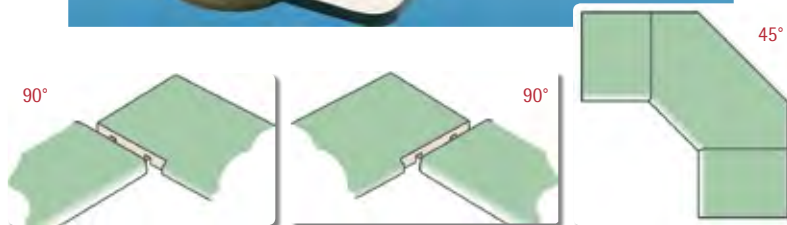

The assembling angle can be 45° or 90°.

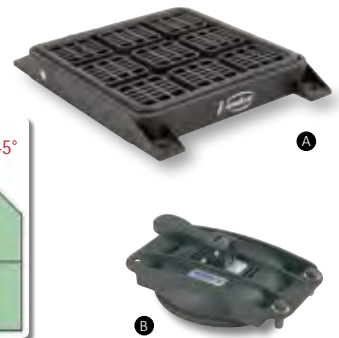

Specifications

Minimum work top width	420 mm
Maximum work top width	650 mm
Assembling angle	45° or 90°

Optional accessories

- 5046347 SVN250 Vacuum clamp system **A**
- 6045699 Suction pad for fixing the template (2 pcs. needed) **B**
- 6045710 Set of 2 jointing screws
- 7722114 Guide ring, external dia. 30 mm., h=10 mm
- 1640258 Bit Ø 12 mm L35 Z3 for 12 mm collet
- 6040310 Bit Ø 12 mm L32 Z2 for 8 mm collet
- 6045711 Set of 10 jointing screws



Video



PE60 | Template for trimming ellipses and circles

Multiradius template for trimming circular or elliptical forms. Ideal for manufacturing mirrors, windows, doors or any other decorative items by means of an elliptical or circular trimming.

The use of the two guide supports (standard equipment) allows the elliptical trimming and the use of only one support allows the circular external trimming or moulding.

The PE60 is also equipped with two suction pads for fixing it to the panel to be trimmed. Thanks to them it is possible to trim in an easy way without to perforate the surface. If it is not possible to use the suction pads there are several holes to fix the template by means of screws.

Includes two rod guides Ø 8 mm for using with all the Virutex routers.



Fixation by suction pads (included) or screws.

Ellipses, max. length of main axis: 3200 mm, min. length of minor axis: 600 mm (with a router).
Circle, max. diameter: 3200 mm, min. diameter 600 mm.

Standard equipment

Template for trimming ellipses and circles, two suction pads, extendable guide and coupling system plus rods Ø 8 mm for Virutex routers.

Optional accessories for PE60 & UC60

- 6045714 Special coupling rods for FR292R
- 6045708 Set of coupling rods Ø 10 mm
- 6045709 Set of coupling rods Ø 12 mm
- 6045710 Set of two clamp screws

UC60 Universal compass guide

For trimming circles between 400 and 3200 mm. (ref. 6045715)

Includes: Support, suction pad, adjustable holding rod and coupling with Ø 8 mm rods for fixing the router.



Oval table

Round table

Opening for rounded door

Opening for oval door

Round corner on a desk

Extendable round or oval table

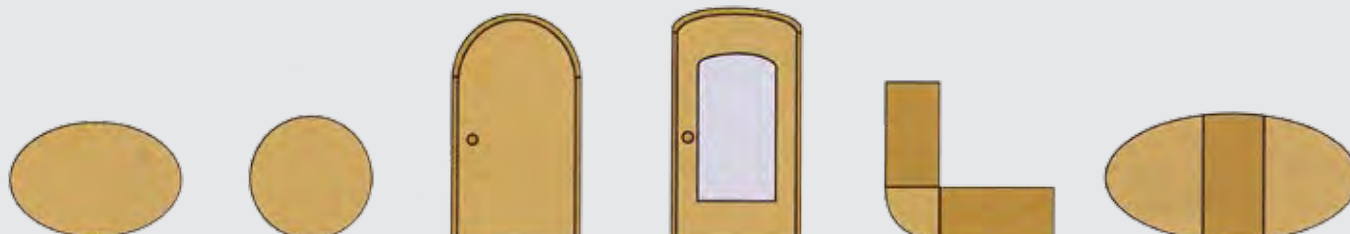



UCP90 | Cutting guide

The UCP90 guide allows a guided cutting, with total stability and precision. Adaptable to all models of Virutex routers allows to make straight mouldings, grooves... in a very easy way.

Equipped from factory with two fixing systems, allowing a safe holding on the piece to work: two suction pads, for smooth and non-porous surfaces and a set of two clamp screws to be fixed on the lower side of the guide, even if the guide is longer than the panel.

The guide is also provided with non-slip strips to protect the panel from possible scratches.



Non-slip strips for a better fixing. They protect the panel from possible scratches.



The guide can be fixed by means of the two suction pads included (on smooth and non-porous surfaces).



Two clampscrews included for fixing the guide from the lower guide.

Standard equipment

Guide 1400 mm long, 2 suction pads and 2 clamp screws.



Adaptable to all Virutex routers by means of the optional adaptor 9045758.



Optional accessories

- 9045758 Adaptor for routers
- 9045754 Guide 1400 mm length **A**
- 9045755 Guide 2400 mm length **B**
- 6045756 Set of 2 suction pads UCP90
- 6045710 Set of 2 clamp screws
- 9045812 Jointing kit for UCP90 guide





PF400/PF700 | Routing templates

Template designed specially for routing open stairs or with riser. Provides a quick and easy routing of the recesses on the stringers without to draw all the dimensions. Reversible, for right and left stringers. Ensures a high precision of routing simplifying the assembly of the treads.



Quick and easy routing of the recesses on the stringers

Routing templates PF400 and PF700 allow complex trimmings with the aid of a router. Among the various working possibilities they offer, include lace and routing grooves, routing perimeter edges or frames or routing arcs and circles.



The routing process is performed with high stability and efficacy.

Max. working area with PF400: 120x320 mm
Max. working area with PF700: 320x620 mm

Optional accessories

6046578 Extension set for stair landings from 600 mm to 1000 mm
3345634 Anglecopy TC133R

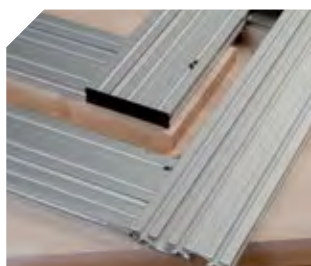

Equipped with a special stopper for a 90° trimming.



The use of PF400 and PF700 templates allows multiple applications.

Video



On demand, different kind of special nosing tread templates (ref. 6033167).



Optional accessories

6046519 Extension set PF200
6046520 Extension set PF400
6046521 Extension set PF700
6045710 Set of 2 clamp screws

The optional base adapter ref. 6046478 is especially useful in those works necessary to work the inside of a large workspace



Standard nosing tread

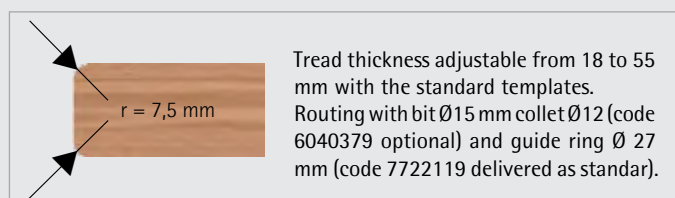

Optional guide rings

7722118 Guide ring for bits Ø max. 13 mm
7722162 Guide ring for bits Ø max. 16 mm
7722119 Guide ring for bits Ø max. 20 mm
7722114 Guide ring for bits Ø max. 23 mm



AB111N | Jointing machine

The jointing machine AB111N is specially designed for slotting panels in any position. Thanks to the design of its micrometric fence, which can be adjusted at any height and angle, and to a graphic signs it is not necessary to take exact measurements, due that it is possible a lateral displacement of 2 cm for adjusting the joint once made the slot. A preadjusted stopper allows to select the different slotting depths fast and easy. Equipped with electronic control system which maintains the speed constant independently to the working load, allowing to make the slots in a easy and precise way in all kind of woods.



Angle and height of the front fence can be adjusted on a graded scale.



Quick adjustment of different slotting depths.



Frontal fence with non slide rubber stoppers for a better machine stability.

Optional accessories

6446073 Standard dust collector attachment 2.25 m

2546409 Gluing set SEM1



Lateral fence CB64B

Cutting back skirting board for placing parquet.



Repairing head CA64B

Optional accessory for the repair of damaged wood (small pockets of resin, knots, etc), blade not included.



Bit for CA64B

Bit for repairing resin pockets on wood. (ref. 6440376) D. 100 MD



Standard equipment

Carbide blade 100 x 22 x 4, of 2 teeth and 2+2 spurs, carrying case, external dust collection connector.



Specifications

Input power	800 W
Blade	100x22x4 mm
No-load speed	10,000/min
Max. slotting depth	20 mm
Weight	2.6 kg

Types of joints

With the AB111N it is possible to perform multiple types of assembly, whether in the middle of the board, a miter square or even frame assemblies.



Joints in middle of board.



Square joints.



Mitre joints.



Stronger joints with No. 6 splines.



Assembly wooden splines

Specially designed for joints. They work like dowels or blocks but with greater advantage. The joint is assured thanks to the resistance of the wooden splines which are more resistant than dowels or blocks.



Ref.	Model	Specifications	Box
1405001	No. "0"	47x15x4 mm. Slot depth 8 mm	1000 un.
1405002	No. "10"	53x19x4 mm. Slot depth 10 mm	1000 un.
1405003	No. "20"	56x23x4 mm. Slot depth 12 mm	1000 un.
1405004	No. "6"	85x30x4 mm. Slot depth 20 mm x2*	500 un.

(*) 2 contiguous slots at 15 mm

Optional accessory

2546409 Hand gluing set SEM1

Contents:

- Plastic bottle of 250 ml
- Dispensers for splines and dowels
- Gluing roller 60 mm width
- Gluing brush
- Caps for each element



AB181 | Trimmer for connectors

Machinespecially designed for trimming the slots to place the OVVO™ automatic connectors for assembling panels. Easy to use, it makes the trimming fast and accurate.

Patented model

Video

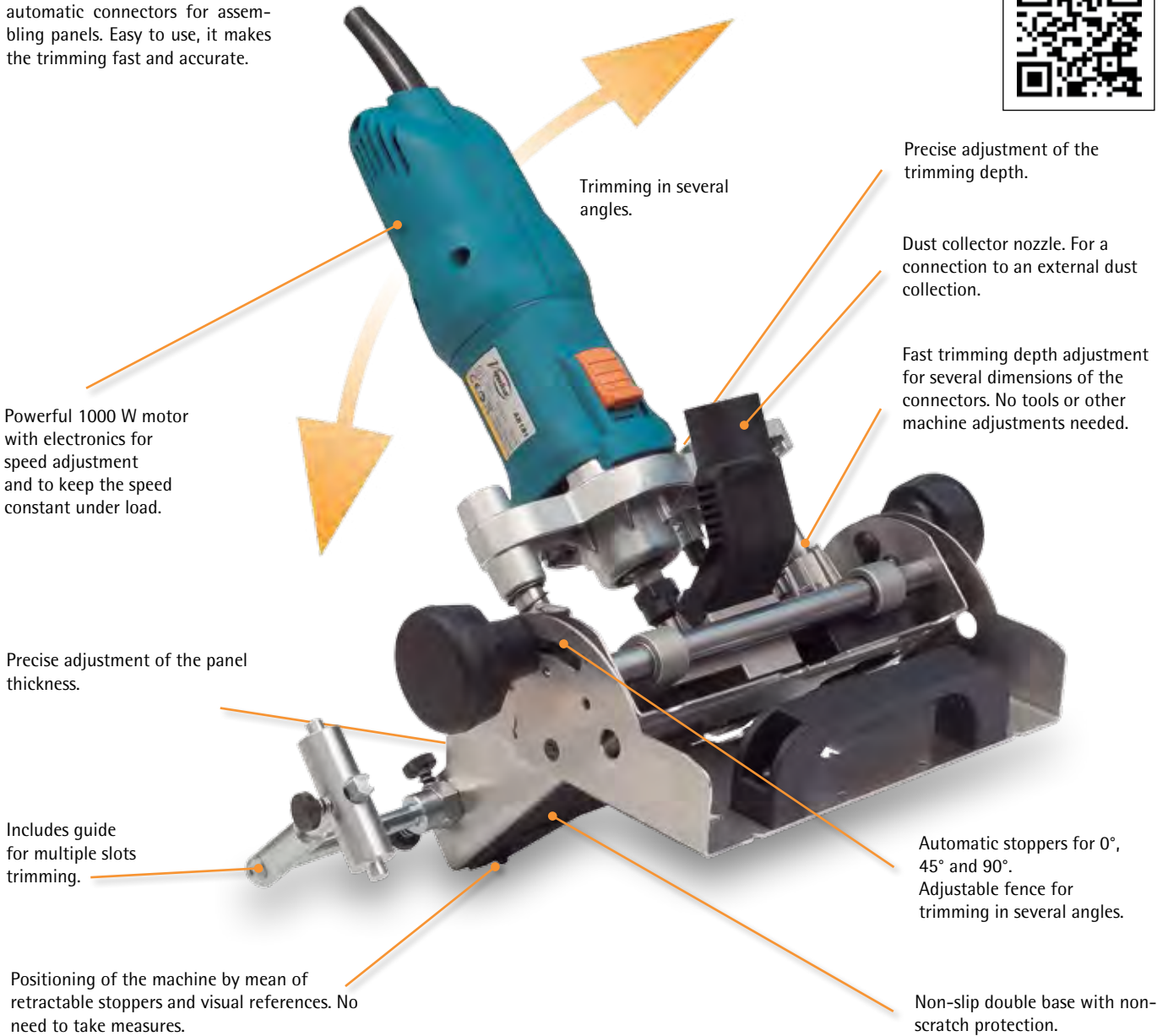

Trimming at 90°



Trimming at 45°



Trimming at 0°

Patented

THE FUTURE OF CONNECTION
OVVO

OVVO® assembling system

The OVVO™ connection system saves assembling time and allows to transport the furnitures in flat parcels, saving time and volume. It is not necessary to use tools, screws or glue to assembly the pieces. The OVVO™ system is a solution to join two pieces easily without to use traditional systems.

Allows a variety of joints and angles.

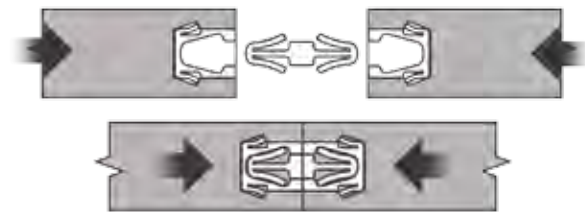

Push > Click > Connect

Very easy operation. Just press both pieces to be assembled, with the connector aligned, until to hear a "click". The assembly is done. It is an invisible solution, with a internal automatic clamp, that creates a perfect union between the two assembled pieces.



An assembling system with unique advantages

- Allows a real invisible assembly.
- Easy to dismount, without tools.
- Easy transport of the parts.
- Fast assembly on site. Time saving.
- Assembly without glue.
- No clamps needed, instant assembly.

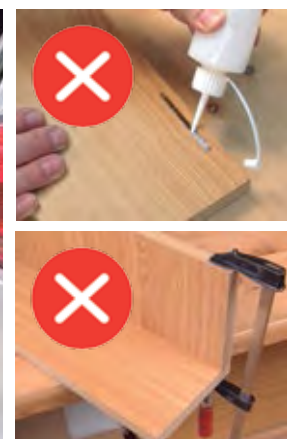
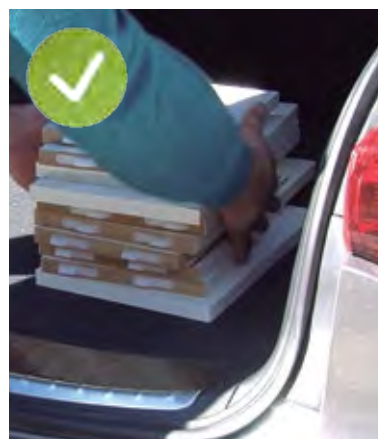



Virutex is the Exclusive Distributor for Spain and Portugal of OVO™ connectors for assemblies.

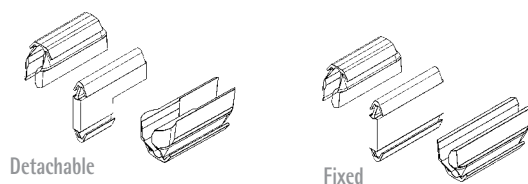

Connectors V1230 for 15 mm boards or thicker

Ref.	Specifications	Boxes
7905031	Detachable connector V1230	1000 un.
7905030	Detachable connector V1230	300 un.
7905029	Detachable connector V1230	100 un.
7905034	Fixed connector V1230	1000 un.
7905033	Fixed connector V1230	300 un.
7905032	Fixed connector V1230	100 un.

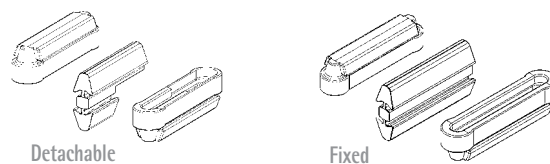

Connectors 1240 for 19 mm boards or thicker

Ref.	Specifications	Boxes
7905005	Detachable connector 1240	1000 un.
7905006	Detachable connector 1240	300 un.
7905007	Detachable connector 1240	100 un.
7905008	Fixed connector 1240	1000 un.
7905009	Fixed connector 1240	300 un.
7905010	Fixed connector 1240	100 un.

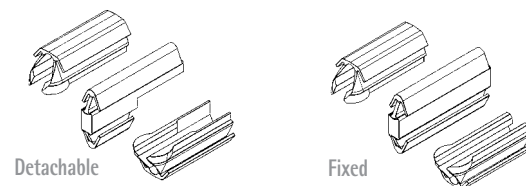

Connectors V0930 for 12 mm boards or thicker in solid wood or high density boards.

Ref.	Specifications	Boxes
7905025	Detachable connector V0930	1000 un.
7905024	Detachable connector V0930	300 un.
7905023	Detachable connector V0930	100 un.
7905028	Fixed connector V0930	1000 un.
7905027	Fixed connector V0930	300 un.
7905026	Fixed connector V0930	100 un.

Optional

Bits for AB181

- Carbide bit for connector 1240 ref. 7940398 (standard equipment)
- Diamond bit for connector 1240 ref. 7940402
- Carbide bit for connector V0930 ref. 7940404
- Carbide bit for connector V1230 ref. 7940411

Accessories for AB181

- Dust collection attachment 5 m ref. 1746245
- Dust collection attachment 2,25 m ref. 6446073
- Pneumatic vacuum clamping system SVN250 ref. 5046347
- AS182K Vacuum cleaner 27 l. ref. 8200100

Bits for CNC (Ø12) (not for AB181)

- Carbide bit for connector 1240 ref. 7940400
- Diamond bit for connector 1240 ref. 7940388
- Carbide bit for connector V0930 ref. 7940405
- Carbide bit for connector V1230 ref. 7940412



Specifications

Input power	1,000 W
No-load speed	14,000-27,000/min
Chuck collet	8 mm
Weight	4.7 kg



FR217S | Angle trimmer

Specially designed for trimming the concave radiuses in the joints between rims and work tops made of materials such as Corian or Ra-solid. Fitted with a front feeler that prevents the rim from becoming damaged and allows for quick, easy trimming, giving a perfect finish. Equipped with a powerful 1,000 W motor with electronic speed adjustment and constant torque control for a constant motor speed under load. Delivered with two special carbide bits for radius 5 and 10 mm. The machine is also fitted with a dust collection connector.



First trimming.

Perfect finishing, total integration of the rim and the work top, leaving them like a single piece.



Standard equipment

- Radius bit R5 HM (1740306)
- Radius bit R10 HM (1740307)
- Chuck collet 8 mm
- Carrying case



Optional bits

- 1740311 Carbide radius bit R6
- 1740312 Carbide radius bit R8

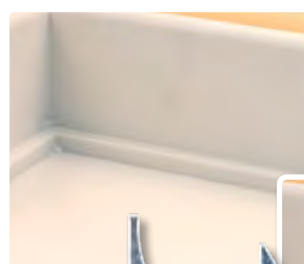

Trimming process in two passes

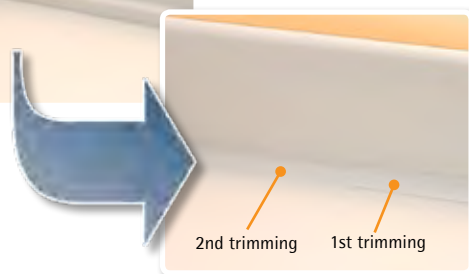

Specifications

Input power	1,000 W
No-load speed	14,000-30,000/min
Chuck collet	8 mm
Max. bit diameter	20 mm
Weight	1.6 kg



Video



FRE317VD | Tilttable router

Specially designed for installing or repairing Corian®. Its features make the FRE317VD the perfect machine for the Corian® installation.

Equipped with a powerful motor (2100 W) with electronic speed control from 11500 to 23000/min this router has the biggest routing depth capacity: 100 mm.

It is also equipped with an additional base for routing the joints and angles on Corian® Worktops. The only router equipped with a gaz buffer for the vertical movement, for the routing of joints on Corian® worktops.

Routing depth adjustable by micro-metric system.

Adjustable stopper with 6 routing depth positions.



Carrying case included on standard equipment.



Exclusivity. The only tiltable router with a gaz buffer.



Big support surface for trimming works on edges.



Fast depth adjustment with 6 pre-adjusted positions.

Standard equipment

Bit for rims r. 10 mm HM, slotting bit d.10 mm HM, lateral fence, chuck collet reducers 12-10, 12-8 & 12-6 mm, guide ring Ø ext. 30 mm, wrench e/c 3 mm, wrench e/c 5 mm, wrench e/c 13 mm, wrench e/c 24 mm, locking rod D. 6, dust collection cover for trimming radius, dust collection connector 5 m with clamps, bit protection and carrying case.

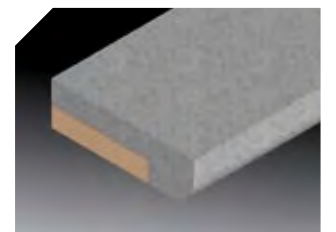
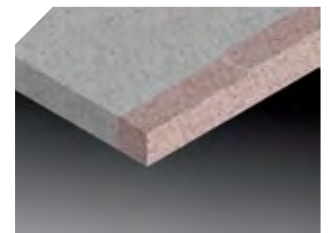

Some applications of the FRE317VD

Specifications

Input power	2,100 W
Standard chuck collet	12 mm
Max. bit Ø	61 mm
No-load speed	11,500-23,000/min
Routing depth	0-100 mm
Weight	5.5 kg





UFN317 pneumatic parallel cutting equipment (ref. 1746846)

1745838 Equipment for parallel cutting and fixation UF317 (includes suction cups)

Replacement of a defective part of the counter. The special features of the FRE317VD, together with this accessory, allow the entire counter cutting, including the edges.



6045756 Set of suction pads

For fixing the machine when drilling holes or caps on Corian® worktops.

Other accessories:

- 9045754 Rail guide long. 1.40 m
- 9045755 Rail guide long. 2.40 m
- 9045812 Jointing kit for 2 guides
- 6045710 Set of 2 clamp screws

Special bits for solid surface material
see pag. 51

Other accessories as router
see pages. 34-39

Guide rings
see pag 31



The ASUN317 clamping system (ref. 1746804)

A pneumatic union system for a solid and stable fixation. It allows a collage of two boards, in an easy and fast way.



1745927 Clamping device ASU317S

Allows a solid and stable fixing when gluing two panels in horizontal position.



ATUN317 union flange (ref. 1746805)

Pneumatic flange for quick attachment of two boards from different angles.



1745928 Elastic clamping device ATU317S

Allows to fix two panels at a different angle, when gluing them.

UC317 drainage milling equipment UC317* (ref. 1746254)

To make the drip tray easily, quickly and accurately. It is possible to adjust the depth and inclination of the milling. The FRE317VD router slides easily over the jig, making the chute slightly sloped for easier evacuation of water.

(*) Must be used with equipment for parallel cuts and UF317S fasteners.



Professional bits

Bevel

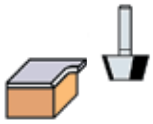

Ref.	D	L	Z	S	d	T	EXP
1140012	22	12	2	15°	6	HM	64
1140023	24	12	4	30°	6	HM	64

Flush/bevel combination

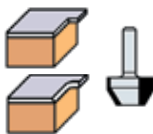

Ref.	D	L	Z	S	d	T	EXP
1140021	24	12	4 mixed	30°	6	HM	64
1040011	22	12	2 mixed	30°	6	HM	64/36

Flush cut with bearing

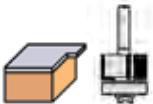

Ref.	D	L	Z	S	d	T	EXP
1140037	22	12	4	0°	6	HM	64/36

Flush cut

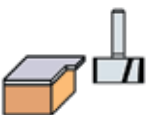

Ref.	D	L	Z	S	d	T	EXP
1140010	18	15	2	0°	6	HM	64/36
1140020	24	12	4	0°	6	HM	64

V-groove

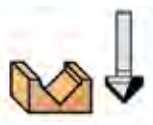

Ref.	D	L	Z	S	d	T	EXP
1140087	20	14	2	45°	8	HM	64/36

Straight

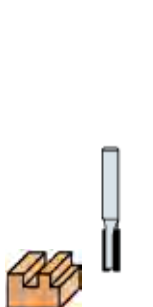

Ref.	D	L	Z	S	d	T	EXP
1140055	6	15	2	0°	8	HM	64/36
1140056	8	20	2	0°	8	HM	64/36
1140057	10	20	2	0°	8	HM	64/36
1140058	12	20	2	0°	8	HM	64/36
6040310	12	32	2	0°	8	HM	
1140059	7,6	20	2	0°	8	HM	64/36
1240024	12	10	2	0°	8	HM	64
1240026	14	10	2	0°	8	HM	64/36
1240027	15	10	2	0°	8	HM	64/36
1240028	16	10	2	0°	8	HM	64/36
1240030	18	10	2	0°	8	HM	64
1240031	19	10	2	0°	8	HM	64
1240032	20	10	2	0°	8	HM	64/36
1140257	10	32	2	0°	12	HM	33

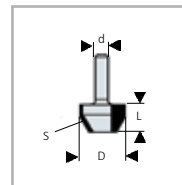

D: Bit diameter,
L: Cutting height,
Z: Number of cuts,
S: Side profile,
d: Shank diameter (chuck collet),
T: HSS= High speed steel HM= Carbide,
EXP: Display

Straight



Ref.	D	L	Z	S	d	T	EXP
1140258	12	32	2	0°	12	HM	33
1640258	12	35	3	0°	12	HM	33
1140259	14	32	2	0°	12	HM	33
6040379	15	30	2	0°	12	HM	
1140260	16	32	2	0°	12	HM	33
9240408	10	25	2	0°	6	HM	

Dovetailing

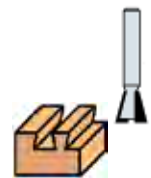

Ref.	Description	d	T	EXP
6040050	Dovetail bit Ø 15 mm (PL11 pitch 26 mm)	8	HM	64/36
1140060	Straight bit Ø 12 mm (PL11 pitch 26 mm)	8	HM	64
5040119	Dovetail bit Ø 9,5 mm (PL11 pitch 16 mm)	8	HM	64/36
5040120	Dovetail bit Ø 19 mm (PL11 pitch 34 mm)	8	HM	64/36
6040053*	Dovetail bit Ø 15 mm	12	HM	33
5040122*	Dovetail bit Ø 19 mm	12	HM	33

For FR66P,
FR160P, FRE160P,
AS93+CA66F, FR277R
& FR278R.
Marked with * only
for FR160P, FRE160P
& FRE317VD.

Rabbeting with bearing



Ref.	D	L	Z	S	d	T	EXP
1142030	32	13	2	0°	8	HM	64/36

Chanfer with bearing



Ref.	D	L	Z	S	d	T	EXP
1132026	20	11	2 mixed	45°	8	HSS	64
1142027	25	15	2 mixed	45°	8	HM	64/36

Straight



Ref.	D	L	Z	S	d	T	EXP
1132036	27	20	2	0°	8	HSS	64
1140016	18	20	2	0°	8	HM	64/36

Radius bits for rims



Ref.	D	L	Z	S	d	T
1740306	10	12	2	r:5	8	HM
1740311	12	12	2	r:6	8	HM
1740312	16	14	2	r:8	8	HM
1740307	20	14	2	r:10	8	HM

Professional bits

Straight



Ref.	D	L	Z	S	d	T	EXP
1132035	20	15	2	0°	8	HSS	64
1132036	27	20	2	0°	8	HSS	64
1140016	18	20	2	0°	8	HM	64/36

Core box

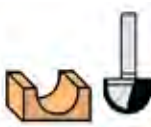

Ref.	D	L	Z	S	d	T	EXP
1132020	20	15	2	r:10	8	HSS	64
1142020	26	18	2	r:13	8	HM	64/36

Double bead



Ref.	D	L	Z	S	d	T	EXP
1142041	25	15	2	r:5	8	HM	64/36

Roman ogee



Ref.	D	L	Z	S	d	T	EXP
1132047	20	15	2	r:7	8	HSS	64
1132048	27	20	2	r:9	8	HSS	64
1142047	25	18	2	r:6	8	HM	64/36

Beading



Ref.	D	L	Z	S	d	T	EXP
1132039	27	15	2	r:10	8	HSS	64
1142039	25	19	2	r:15	8	HM	64/36
1142239	32	16	2	r:10	12	HM	33
1142339	38	19	2	r:12	12	HM	33

Roman ogee w/bearing



Ref.	D	L	Z	S	d	T	EXP
1142045	26	17	2	r:7	8	HM	64/36
1142245	38	17	2	r:6	12	HM	33

Beading with bearing



Ref.	D	L	Z	S	d	T	EXP
1142024	26	15	2	r:12	8	HM	64/36
1142224	38	19	2	r:12	12	HM	33

Cove and bead w/bearing



Ref.	D	L	Z	S	d	T	EXP
1142040	26	15	2	r:5	8	HM	64/36
1142140	35	17	2	r:6+5	12	HM	33

Moulding bit with bearing



Ref.	D	L	Z	S	d	T	EXP
1142150	32	16	2	r:8	12	HM	33

Corner rounding



Ref.	D	L	Z	S	d	T	EXP
1140107	23	12	2	r:6	8	HM	64
1140108	27	16	2	r:8	8	HM	64

Corner rounding with bearing



Ref.	D	L	Z	S	d	T	EXP
1140123	19	10	2	r:2	8	HM	
1140106	20	10	2	r:3	8	HM	64/36
1140109	25	11	2	r:6	8	HM	64
1140110	29	15	2	r:8	8	HM	64

Moulding bit



Ref.	D	L	Z	S	d	T	EXP
1140300	24	24,5	2	r:16	12	HM	33

Moulding bit



Ref.	D	L	Z	S	d	T	EXP
1140301	32	36	2	r:10	12	HM	33

Moulding bit



Ref.	D	L	Z	S	d	T	EXP
1140302	21	22	2	r:3	12	HM	33

Moulding bit



Ref.	D	L	Z	S	d	T	EXP
1140303	19	32	2	r:5	12	HM	33

Beading



Ref.	D	L	Z	d	T	EXP
1142160	35	25	2	12	HM	33

Counter moulding bit

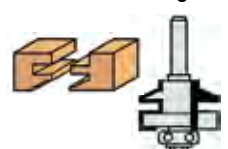

Ref.	D	L	Z	d	T	EXP
1142161	35	25	2	12	MD	33

Professional router bits

Slotting cutter

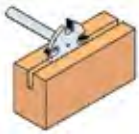

(**) L=Slot thickness

Ref.	D	L**	Z	S	d	T	EXP
1140111	41	2,5	4	0°	8	MD	
1140112	41	3	4	0°	8	MD	
1140113	41	4	4	0°	8	MD	64/36
1140114	41	5	4	0°	8	MD	

Slotting and trimming device

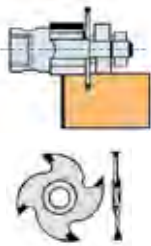

Ref.	Description	d	T
1100008	Slotting device 2.2 mm	Shaft	HM
1100009	Slotting device 1.8 mm	Shaft	HM
1140066	Saw blade Ø 41 thick. 2.2 mm		HM
1140067	Saw blade Ø 41 thick. 1.8 mm		HM
1140072	Saw blade Ø 41 thick. 1.6 mm		HM

(For use with AS93)

Bits for trimming corners

(For use with FR817T or FR217S)

Ref.	D	L	Z	S	d	T
1740189	12	9	2	45°	8	MD

Double bits for slotting

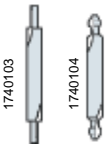

Ref.	Description	d	T	EXP
1740103	Slotting bit e=3 MD	6	MD	64/36
1740104	Anchor slotting bit	6	MD	64/36
1740124	Mixed slotting bit	6	MD	

Slotting device

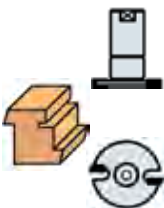

(For use with CR94D)

Ref.	Description	d	T
1850046	Bit holder w/bit Ø 38x3,5	Shaft	MD
1840040	Slotting bit Ø 38x3,5	Shaft	MD
1840051	Slotting bit Ø 55x3,5	Shaft	MD
1840083	Slotting bit Ø 38x4	Shaft	MD
1840084	Slotting bit Ø 55x4	Shaft	MD
1850045	Bit holder without bit		

Installation kit for invisible hinges



(For use with FR129VB)

Ref.	Description	D
2946768	Set guide+conduit axe+bit	15
2946767	Set guide+conduit axe+bit	16
2946766	Set guide+conduit axe+bit	20

Mortising bit for FR160P, FRE160P y FR66P



Ref.	Description	d	D	T
1640258	Mortising bit (FR/FRE160P)	12	12	MD
1640157	Mortising bit (FR66P)	12		MD

Cutter for placing bottom-hung fittings

Ref.	Description	D	L	Z	d
7740117	For AGB fittings (For use with FR277R, FR278R)	16	25	2	Shaft
6040313	For AGB fittings (For use with FR160P, FRE160P)	16	35	2	12

Tools for cordless drill ATB40

Ref.	Description
4040421	Low friction countersink bit with depth stop
4040423	Drill bit for hinges with depth stop

Router bits display

Ref.	Description
1299119	Display with 36 bits
1299120	Display with 64 bits
1299200	Display with 33 bits (for collet 12 mm) & mortising bits

The column "EXP" indicates the contents of each display.



Bits for Corian® and other solid surface materials

D: Max. cutting diameter
 d: Collet diameter or diameter as showed on the picture.
 L: Cutting length
 R: Main radius
 r: Radius as showed on the picture
 a°: Angle
 TL: Total length
 Rpm máx.: Max. speed x min⁻¹

NOMENCLATURE

2 cuts carbide straight bit

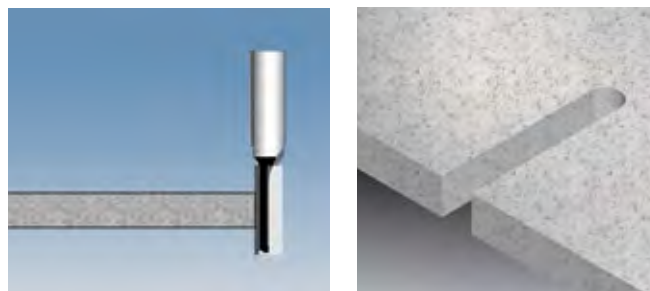

Ref.	EAN13	D	d	L	TL	Rpm max.
1140257	8421752065000	10	12	32	73	
1140258	8421752065017	12	12	32	73	

2 cuts helicoidal full carbide bit

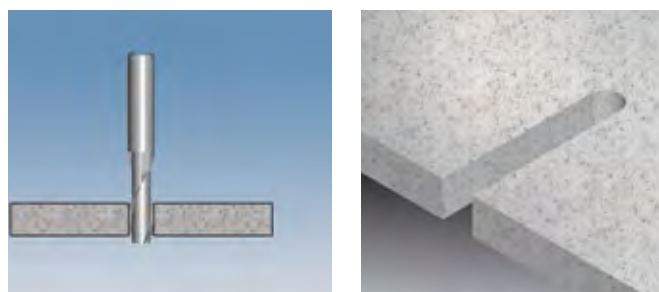

Ref.	EAN13	D	d	L	TL	Rpm max.
1740332	8421752077317	10	10	35	73	
1740333	8421752077324	12	12	45	84	

Carbide bit for rims

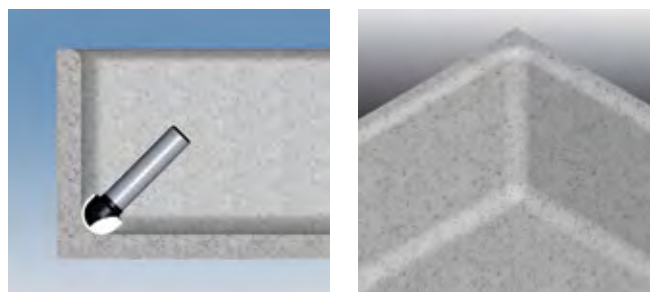

Ref.	EAN13	D	d	L	R	TL	Rpm max.
1740362	8421752078369	20	12	14	10	65	18000
1740363	8421752078376	10	12	13	5	69	20000

Carbide bit for rims



Ref.	EAN13	D	d	L	R	TL	Rpm max.
1740322	8421752077614	10	12	13	5	69	20000
1740324	8421752075801	20	12	14	10	65	18000

Trimming carbide bit 45°x26

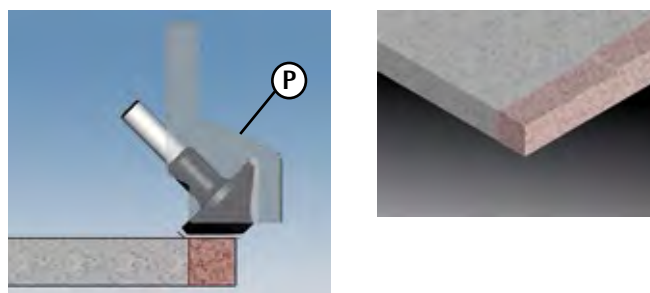

Ref.	EAN13	D	d	L	a°	TL	Rpm max.
1740349	8421752077485	50	12	26	45°	80	20000

Carbide trimming bit w/upper bearing

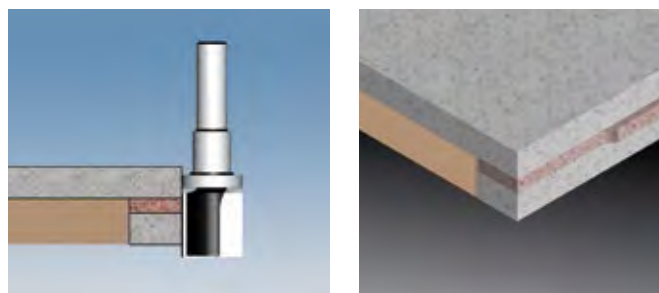

Ref.	EAN13	D	d	L	TL	Rpm max.
1740347	8421752077461	24	12	25	84	

Fraise à chanfreiner 15° avec GAB conique

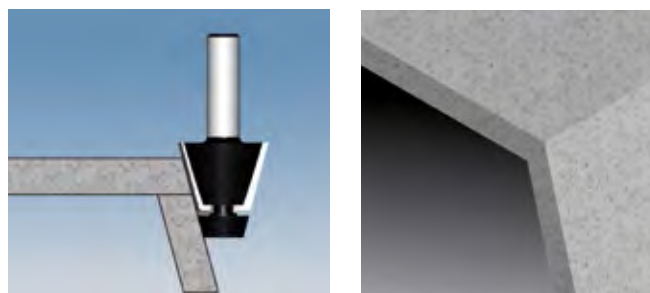

Ref.	EAN13	D	d	L	a°	TL	Rpm max.
1740341	8421752077409	33,5	12	25	15°	75	

Bits for Corian® and other solid surface materials

Carbide trimming bit w/lower bearing

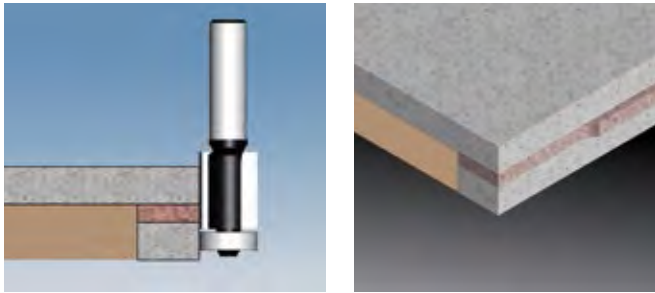

Ref.	EAN13	D	d	L	TL	Rpm max.
1740348	8421752077478	19	12	25	75	

Carbide drilling and 15° bevel bit

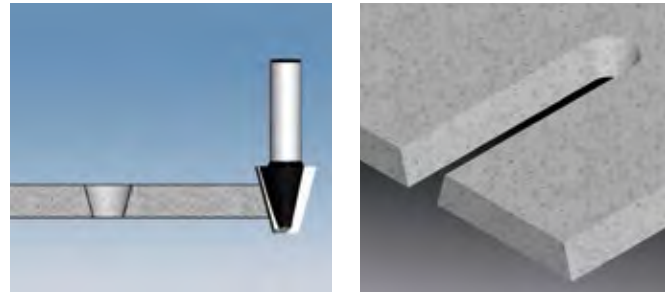

Ref.	EAN13	D	d	L	a°	TL	Rpm max.
1740344	8421752077430	23	12	25	15°	65	

Lower radius carbide bit w/upper bearing

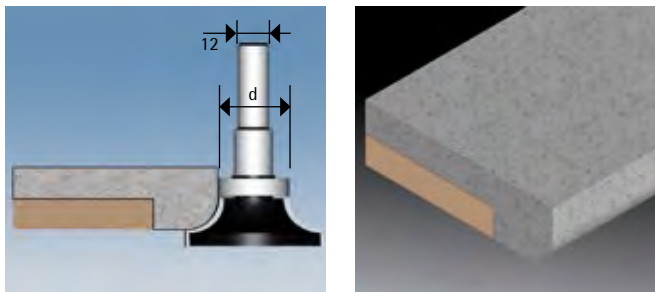

Ref.	EAN13	D	d	L	R	TL	Rpm max.
1740340	8421752077393	54	28	19	12	80	20000

Dovetail carbide bit 15°

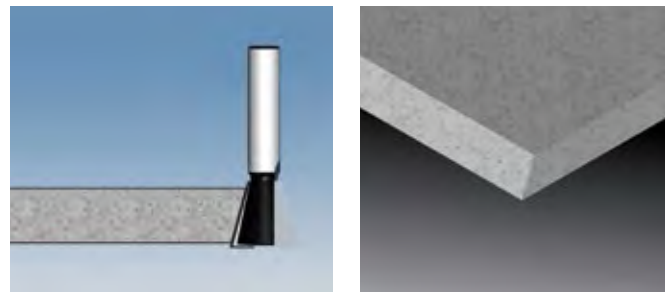

Ref.	EAN13	D	d	L	a°	TL	Rpm max.
1740346	8421752077454	25	12	25	15°	75	

Trimming carb. bit for sinks w/bearing

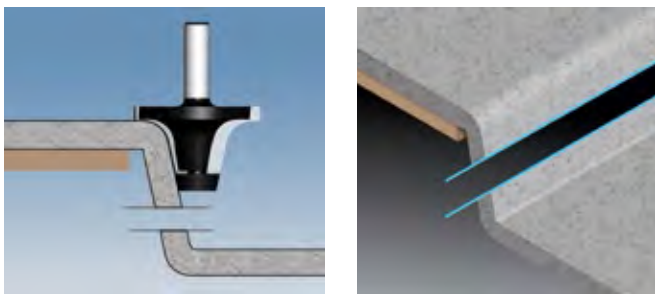

Ref.	EAN13	D	d	L	R	a°	TL	Rpm max.
1740342	8421752077416	49	12	25	6	12°	83	
1740343	8421752077423	60	12	24	12	12°	80	20000

Carb. bit for round edge w/bearing



Ref.	EAN13	D	d	L	R	r	TL	Rpm max.
1740336	8421752077355	27	22	20	5	24	83	

Straight carb. bit R 6 w/bearing

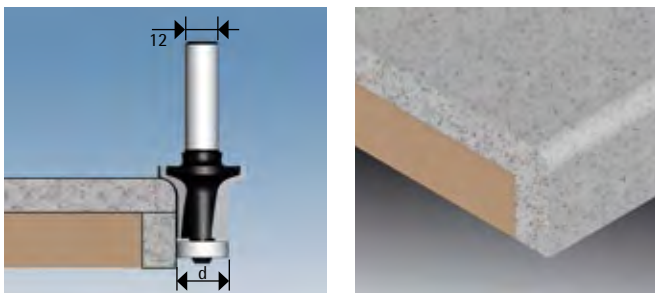

Ref.	EAN13	D	d	L	R	TL	Rpm max.
1740350	8421752077492	32	19	22	6	78	

Carbide bit for edges

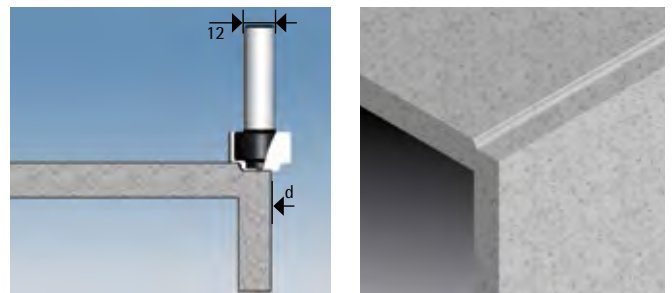

Ref.	EAN13	D	d	L	R	TL	Rpm max.
1740345	8421752077447	24	16	12+3	2	56	

Bits for Corian® and other solid surface materials

Upper radius carbide bit w/lower bearing

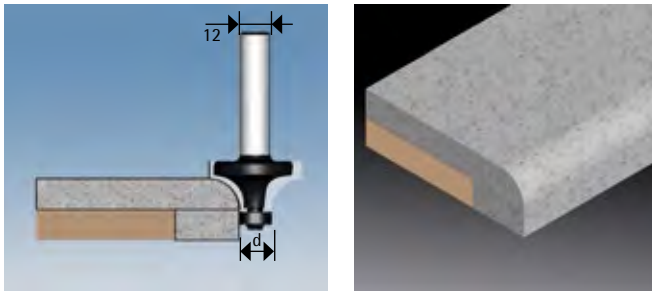

Ref.	EAN13	D	d	L	R	TL	Rpm max.
1740337	8421752077362	28	12	13	6	68	
1740338	8421752077379	40	12	19	12	77.5	

Conical drilling carbide bit

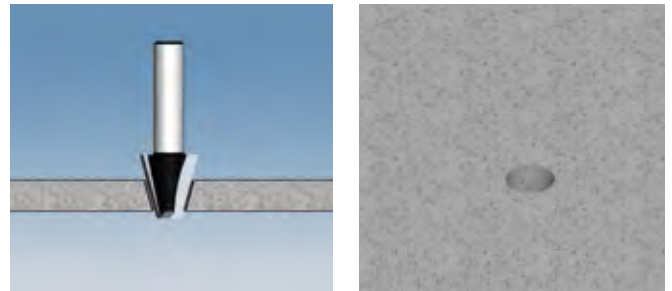

Ref.	EAN13	D	d	L	a°	TL	Rpm max.
1740353	8421752077546	23	12	25	15°	70	18000
1740354	8421752077553	34	12	25	15°	70	16000
1740355	8421752077560	45	12	25	15°	70	12000

Caps drilling carbide bit

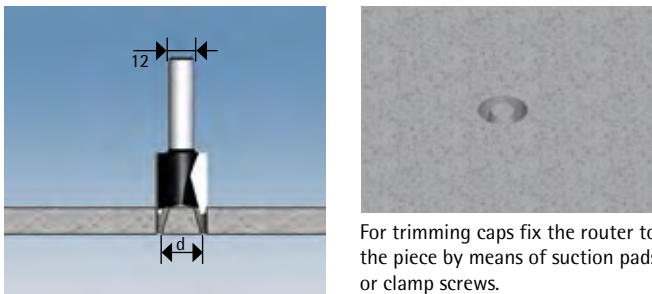

Ref.	EAN13	D	d	L	a°	TL	Rpm max.
1740356	8421752077577	24	18	18	15°	74	20000
1740358	8421752077591	41	33	18	15°	74	16000
1740359	8421752077607	53	45	18	15°	74	12000

Specifications subject to change without previous notice.
Corian® is a trade mark of E.I. du Pont de Nemours and Company..



CR94D | Slotting machine

Trimmer specially designed for slotting doors and windows. Allows insulating joints to be placed without removing the fittings. Ideal for fitting VIRUTEX PVC and rubber joints.



Slotting a window, flashing side.



Slotting a window, hinges side.



Slotting a window, lock side.



Standard equipment

Carbide bit $\varnothing 38 \times 3,5$ mm (1840040), lateral guide and service keys

Rubber & PVC insulating joints

see page 56

Slotting bits

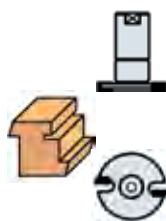

Ref.	Description	d	T
1850046	Bit holder w/bit $\varnothing 38 \times 3,5$	Shaft	HM
1840040	Slotting bit $\varnothing 38 \times 3,5$	Shaft	HM
1840051	Slotting bit $\varnothing 55 \times 3,5$	Shaft	HM
1840083	Slotting bit $\varnothing 38 \times 4$	Shaft	HM
1840084	Slotting bit $\varnothing 55 \times 4$	Shaft	HM
1850045	Cutter holder without cutter		

Specifications

Input power	550 W
No-load speed	30,000/min
Weight	2.5 kg





NEW



RA17VG | Slotting machine

Machine specially designed for slotting wooden doors and windows, for installation of silicon insulating joints. Equipped with double point 3 mm bit, two interchangeable bases, lateral fence, dust collector pipe and carrying case.



Equipped with 2 types of interchangeable fences which allow you to make slots at 45° angle or straight.



With centering pivot easing entry of the bit at the start of slotting process.

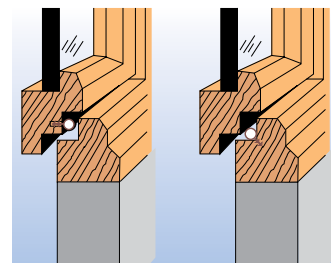

Slots on windows, doors or frames.

Optional accessoires

- 1222024 Chuck collet 8 mm
- 1222085 Chuck collet 6.35 mm (1/4")
- 1740103 Double slotting carbide bit for slot e=3
- 1740104 Double slotting carbide bit for anchor slot

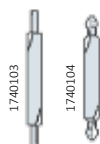

Silicon insulating joints:

see page 56



Standard equipment

Carrying case, combined double side bit, 90° guide, straight guide, reversible fence, depth gauge, service keys and dust collector connection 2.25 m.

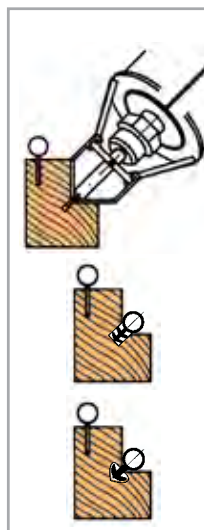

Using a 90° fence, slots at 45° angle on rabbated frames and windows.

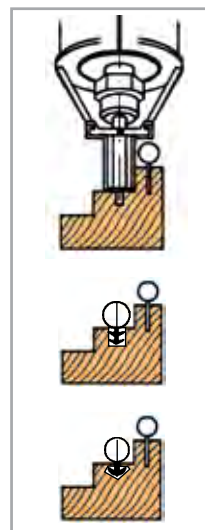

Using the straight fence: straight slots on rabbated frames and windows.

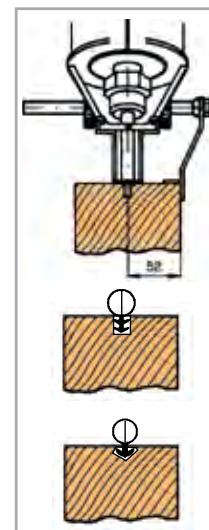

Using the straight fence and reversible square, slots on smooth areas such as the side of door hinges.



Specifications

Input power	1000 W
Chuck collet	6 mm
No-load speed	14,000-30,000/min ⁻¹
Weight	1.9 kg

Consumables

Insulating joints

Essential for good insulation against the cold or the heat. Also give sound proofing against external noise. Perfect fit and adjustment, preventing entry of dust, smoke or humidity. Long lasting effective system which does not wear and maintains its flexibility permanently. Essential for new construction and easy to adapt to existing constructions.

Thermofusing rubber

Ref.	Description (Slotting with CR94D)
1204047	N11GT type 75 m (black colour) Min. rabbet 11 mm. Groove 10x3.5 mm
1204048	N10GT type 75 m (black colour) Min. rabbet 10 mm. Groove 10x3.5 mm
1204049	N9GT type 75 m (black colour) Min. rabbet 9 mm. Groove 8x3.5 mm
1204050	FGT type 100 m (black colour) Groove 6x3.5 mm



P.V.C.

Ref.	Description (Slotting with CR94D)
1204038	N11P type 75 m (brown colour). Min. rabbet 11mm. Groove 10x3.5 mm.
1204039	N10P type 75 m (brown colour). Min. rabbet 10 mm. Groove 10x3.5 mm.
1204040	N9P type 75 m (brown colour) Min. rabbet 9 mm. Groove 8x3.5 mm.
1204140	N9P/B type 75 m (white colour) Min. rabbet 9 mm. Groove 8x3.5 mm.



P.V.C.

Ref.	Description (Slotting with CR94D)
1204041	FP type 100 m (brown colour) Groove 6x3.5 mm
1204141	FP/B type 100 m (white colour) Groove 6x3.5 mm
1204036	PL11P type 75 m (brown colour) Min. rabbet 11 mm. Groove 8x3.5 mm
1204037	PL10P type 75 m (brown colour) Min. rabbet 10 mm. Groove 8x3.5 mm
1204042	PP type 100 m (brown colour) Groove 8x3.5 mm



Silicon insulating joints

Maximum duration, excellent resistance to different climates and elasticity. They resist between -60 to 200 C.

Ref.	Description (Slotting with RA17VG)
1204081	FS1 type 100 m (brown colour) Diameter 8 mm. Groove 5x3 mm
1204181	FS1/B type 100 m (white colour) Diameter 8 mm. Groove 5x3 mm
1204086	FS3 type 100 m (brown colour) Diameter 6 mm. Groove 5x3 mm
1204186	FS3/B type 100 m (white colour) Diameter 6 mm. Groove 5x3 mm
1204082	FS2 type 100 m (brown colour) Diameter 8 mm, anchor groove
1204182	FS2/B type 100 m (white colour) Diameter 8 mm, anchor groove
1204087	FS4 type 100 m (brown colour) Diameter 6 mm, anchor groove
1204187	FS4/B type 100 m (white colour) Diameter 6 mm, anchor groove



Placing rollers

For placing insulating joints



Ref.	Description
1746158	Roller for FS1, FS1/B, FS2, FS2/B, FS3, FS3/B, FS4 and FS4/B types
1850036	Roller for FP, FP/B and FGT types
1850037	Roller for N9P, N9P/B, N9GT, N10GT, PL10P, N10P and PP types
1850047	Roller for PL11P, N11P, N11GT types

Video



Patented model

RM95S | Door frame cutting machine

The definitive solution for changing doors on restoration works, keeping the original door dimensions.

Adjustable cutting up to 155 mm width. It is also possible to cut the crossbeam. The powerful 1800 W motor, soft starting and chain saw give an easy and fast cutting.

Quick assembly and adjustment.

Pinion rack system, for a smooth movement and cut with no-return system for a safety operation.

Dust collector connection and cord 5 m long.



Equipped with an effective chain saw for a clean and easy cut. Fitted with safety protections to avoid any contact with the chain saw, even during the cut.



Solid and efficient pinion rack system for a total control of cut.



Practice system to fix the machine to the frame and to adjust the cutting width.

Clean cut allowing to fix the new frame directly on the old ones.



Standard equipment

- Cutting machine with chain saw
- Metal detector **A**
- Carrying case for the machine
- Carrying bag for the guides
- Lubricating oil (125 ml)



Specifications

Input power	1,800 W
Chain saw speed	15 m/s
Max. cutting depth	155 mm
Chain saw	3/8" 41 links
Weight	20.5 kg



Optional accessories

- 7000910 RV170U set for cutting frames up to 68 mm width
- 9500150 AC95R accessory for cutting crossbeams
- 9599263 Lubricating oil for RM95R (1 litre)
- Only for special purposes when the standard guide is too high.
- 9545751 Upper guide max. height 194 cm
- 9545752 Upper guide max. height 206 cm



Trolley for transport

RMV70U | Door frame cutting machine

The RMV70U door and window frame trimmer is used to trim door and window frames up to 68 mm thick, allowing their original size to be retained. It has a hard metal saw blade which trims very quickly while moving over a detachable guide, so guaranteeing a guided and stable cut. The machine comes as standard with the guide for trimming door frames and with the accessories required for trimming window frames, a process which does not require the guide because the RMV70U has an adjustable front square which efficiently guides the machine while trimming the frame. The RMV70U comes with an effective external dust collecting system and for which a dust collection tube compatible with the entire Virutex range of dust collectors is included as standard. The RMV70U can be quickly assembled and adjusted and since all of the equipment fits into a practical case with wheels, included as standard, it is very easy to transport.



Clean cut allowing to fix the new frame directly on the old ones.



Trimming wooden window frames. Register on the adjustable front guide square.



Diamond blade for cutting building materials for the complete extraction of the frame. Register on the bevelled front of the reversible base.



Makes cutting slots in the 4 corners easy. Register on the bevelled front of the reversible base.

Standard equipment

Guide and accessories for trimming door frames, front fence for trimming windows, 30z MD blade for trimming wood. 3m dust collection tube, metal detector (A) and a practical carrying case with wheels.



Specifications

Input power	1,700 W
No-load speed	6,500/min
Max. cutting depth with saw blade	68 mm
Driving unit weight	6.6 Kg
Total equipment weight	29 kg

Optional accessories

7040329 D.180 diamond blade to "dig out" window frames. Maximum cutting depth: 58 mm
 9500250 MRM95S chainsaw. Allows you to make cuts of up to 155 mm thick in door frames and includes all of the accessories required to adapt it to the guide included as standard with the RMV70U.



RV70U | Window frame cutting machine

The new RV70U trimmer is designed to cut wooden window frames and for use in restoration work or window replacement by creating slots around the frame, making it easier to extract the frame support.

For window frame cutting, the RV70U is equipped with a special saw blade of 12 hard metal teeth and an adjustable front square guide which is used as a support guide for the cut. To create slots in the frame support structure, the RV70U also comes with a diamond blade designed to cut building materials. It can even make slots in the four corners; to do this the user simply has to change the position of the machine's reversible base to the bevelled side.

The new RV70U makes the task of replacing windows much easier while retaining the original size or even increasing it in some cases. It is also an indispensable tool for installing aluminium or wooden windows.



Trimming wooden window frames. Register on the adjustable front guide square.



Diamond blade for cutting building materials for the complete extraction of the frame. Register on the straight front of the reversible base.



Makes cutting slots in the 4 corners easy. Register on the bevelled front of the reversible base.

Carbide saw blade for wood 12Z Ø 200 (ref. 7040371) and diamond blade Ø 180 (ref. 7040329) for building materials as standard equipment.



Standard equipment

Front square guide to trim windows, 12Z MD D.200 blade to cut wood, D.180 diamond blade to cut building materials, 3-m dust collection tube and carrying case.



Optional accessories

9545854 Kit GRM70S: includes the guide and the accessories needed to turn the RV70U into a door frame trimmer.
7040330 Saw blade D.200 30 Z

Specifications

Input power	1,700 W
No-load speed	6,500/min
Max. cutting depth with saw blade	68 mm
Max. cutting depth diamond blade	58 mm
Height of the cut from the base	7 mm
Weight	6.6 kg



Video



FR129VB | Router for fitting hinges

Special router for installation of all kind of hinges on frames and any kind of doors.

Easy fitting of 3 or 4 hinges per door (right or left open), without to take measurements and marking.

The double depth stopper allows to mortise both depths of concealed hinges in one operation, without changing the template. The router is also prepared for fitting any kind of traditional hinges. New and easy to adjust clamp system that holds the router perfectly on the door and frame, without damaging its surface. To place the template on the machine is also very fast; it is fixed and ready to use by pressing it inside the guide.

The FR129VB is equipped with a powerful motor of 1,000 W, electronic speed adjustment and electronic system to maintain constant speed under load. Carrying case included.

Models:

Router for hinges FR129VB with kit for concealed hinges. Allows to fit hinges with or without template. Available with kits of Ø 14, 15, 16 & 20 mm.

Router for hinges FR129VB for fitting hinges with or without template. Kit for concealed hinges in option.



Making the upper recess on the frame.



Making the second recess on the frame.

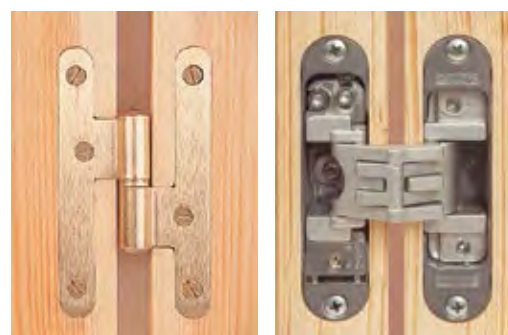

Perfect finishing. Installation of concealed hinges in fast and one step operation. No need to change the template.



Standard equipment

Carbide bit Ø 7.6 mm (ref. 1140059) and guide ring ref. 2950105, 2 recess distributor rods for 3 or 4 hinges, service keys, carrying case.

To make other recesses both on frames and doors it is not necessary to readjust the machine.

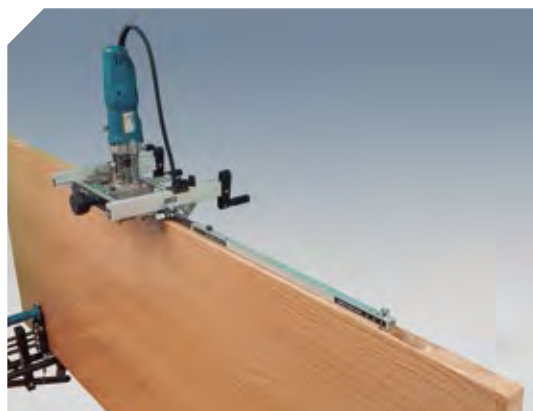

Optional accessories

Kits for fitting concealed hinges

- 2946765 kit for fitting concealed hinges with carbide bit Ø14 mm
- 2946768 kit for fitting concealed hinges with carbide bit Ø15 mm
- 2946767 kit for fitting concealed hinges with carbide bit Ø16 mm
- 2946766 kit for fitting concealed hinges with carbide bit Ø20 mm



Guide rings

- 2950104 Ø ext. 10 mm (for 6 mm bits)
- 2950105 Ø ext. 12 mm (for 8 mm bits)
- 2950106 Ø ext. 14 mm (for 10 mm bits)
- 2950107 Ø ext. 16 mm (for 12 mm bits)
- 2950081 Ø ext. 18 mm (for 14 mm bits)
- 2950108 Ø ext. 20 mm (for 16 mm bits)

Bits

- 1640383 Carbide bit Ø14 mm
- 1640379 Carbide bit Ø15 mm
- 1640127 Carbide bit Ø16 mm
- 1640367 Carbide bit Ø20 mm



RC29M Corner chisel (optional)

This accessory allows to cut the radiuses left by the bit on the corners of the trimmed recesses for hinges, giving an exact 90° corner. It is very useful when fitting hinges with square corners.

Solid and ergonomic design protects the user from the cutting blades.

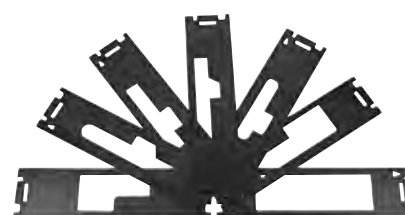
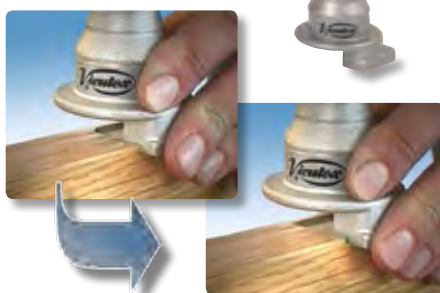

Optional accessories

- Templates for fitting different types of hinges
- 2935142 Special eyebolt templates

Specifications



Input power	1,000 W
No-load speed	14,000 - 27,000/min
Chuck collet	8 mm
Max. bit diameter	32 mm
Max. trimming dim.	165 x 74 mm
Max. trimming depth	11 mm

Max. trimming depth (with kit for concealed hinges)	40 mm
Max. clamp opening*	200 mm
Min. clamp opening	33 mm
Weight	4.3 kg

(*) Also available with max. opening clamp up to 250 mm.



Templates for fitting hinges



3 body template holder A093.



Templates for fitting hinges

VIRUTEX pin hinge templates are designed to facilitate the quick seating of all types of hinges. Allows seating the hinges without taking measurements of either the door frame or the door. Can be adjusted to work at any recess depth. Functions equally for both left and right side opening doors and for any standard or intermediate door height. Very easy operation using a VIRUTEX trimmer with the appropriate head. By order, we manufacture templates for any type of hinge. The special templates are manufactured with the help of laser technology to ensure a high quality finish. There are three models of template-holders which can be combined with the different templates depending on the type of hinge, including security doors with 4 hinges.



Fitting on a frame.
(Mod. A093)



Fitting on a door.
(Mod. A093)

Template holders

3600000 A093 Three-body template holder for fitting hinges

3900000 AM94 Four-body template holder for fitting hinges

1900000 AV93 Single body template holder for fitting hinges

1900200 PP19H Single body template holder for fitting eyebolts



Mod. PP19H



Mod. AV93

The ideal machine for fitting hinges



FR192VG trimmer

Templates for fitting different types of hinges.



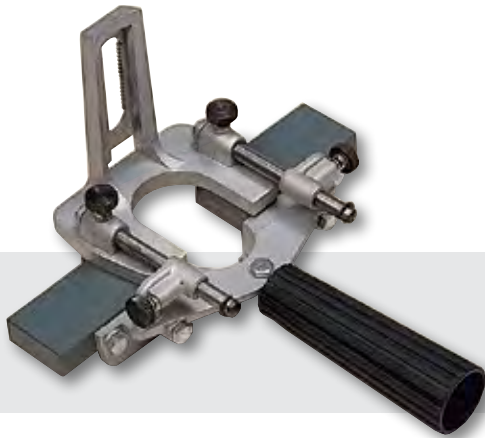

ZB93 | Trimming head for fitting hinges

The ZB93 head is specially designed to be used together the FR192VG trimmer for fitting hinges without template. The combination of both tools offers a practice and professional solution for placing hinges without template.



Placing hinges with the ZB93 head.



EP70P | Door lifter

The EP70P door lifter is ideal for taking out heavy or light doors in an easy way. It allows to lift heavy doors like armored doors or fire doors. Its design allows to turn the tool to both sides, making easier the extraction of the door. Furthermore the frontal part is adjustable helping a lot the task of placing the door. The adjustable frontal platform allows a precise work and is covered by a special material against possible scratches. Easily transportable due to its light weight (1 Kg).



Easy and fast extraction of doors, also in difficult cases.

RC29M Corner chisel

This accessory allows to cut the radiuses left by the bit on the corners of the trimmed recesses for hinges, giving an exact 90° corner. It is very useful when fitting hinges with square corners. Solid and ergonomic design protecting the user from the cutting blades.



90° corners with a perfect finishing and in a fast way.



2931093 Set of 2 blades for RC29M

Specifications

Blades dimensions	20x20 mm
Max. cutting radius	20 mm
Max. cutting depth	6 mm

Specifications

Maximal weight supported	200 Kgs
Weight	1 kg



SP270R | Clamping support

Practical support allowing to hold firmly any piece (panels, doors...) for working safely. High stability. It is possible to hold panels or doors from 6 to 80 mm thickness. It can hold pieces up to 80 kg weight.



Ideal for fixing doors, panels, etc...



Facilitates the work on doors, allowing a fast and safety fixation.

Specifications

Max. piece thickness	6-80 mm
Max. piece weight	80 kg
Weight	3 kg

7046632

Hinges key

Ideal to unbend hinges on metal doors.



For hinges Ø 18 and 16 mm.



SPR770T | Clamping support with wheels

Practical support with wheels allowing just one person to hold and carry all kind of panels, heavy doors, carpentry parts in wood, aluminum, PVC, etc.

Clamp opening from 6 to 110 mm, both are protected to avoid to damage the holded piece.

Easy and fast use, the piece to be holded is fixed just only with its pressure. Easy extraction thanks to the foot pedal.

The two inflatable pneumatic wheels allow to move the SPR770T in a easy way, even to go up some stairs. The wheels can be blocked for a stationnary use of the support, so it is possible to do some work on the door or panel.

Practical and strong design, ideal for several kind of works for the professional woodworkers.

It is possible to hold and carry pieces up to 200 kg weight.



Allows just only one person to hold and carry all kind of panels, heavy doors.



Carrying a large panel on an irregular floor.



Wheels can be blocked for a stationnary use, so it is possible to work on the edge of the panel or the door.

Specifications

Max. piece thickness	6-110 mm
Max. piece weight	200 kg
Weight	8 kg



Ideal for making lock mortises.

Mount any lock with the FC116U

FC116U | Lock mortiser

Specially designed for quick, precise mortising on doors or other elements, either at the work site or in the workshop. Its special fixing system allows the mortising of doors that have already been hung, without damaging the surface. Its quick measurement adjustment permits multiple mortises to be made in record time. Possibility to trim the frontal lock plate just changing the bit. Equipped as standard with the accessory UT16I which allows to take references for drilling the hole for the handle and key cylinder. Also able to work horizontally. For mortising grooved doors or those with overlap, there is an adjustment system to centre the machine. Optional bits are low cost and easily interchangeable, as they use the same tool-holding shaft.



The machine is also able to work horizontally. Especially useful if deciding to make a series of mortises, with the doors unhung.



Wooden box for carriage.

It also permits to mortise grooved doors or those with overlap, thanks to the possibility of adjusting the centre of the machine over the section of the door where the mortise is required.



Standard equipment

Equipped from factory with carbide lock mortiser bit Ø 16 mm, locking bar to make mortises on several doors at the same height, rubber protectors for delicate jobs, service keys, dust collector connection and UT16I drilling accessory.

Video



The FC116U incorporates a locking bar, which is fixed to the machine at the height from the ground established for the first mortised door, allowing the mortising of the rest of the doors at the same height without retaking measurements.

Specifications

Input power	1,100 W
Max. bit Ø	30 mm
No-load speed	23,000/min
Max. mortising depth	0-125 mm
Max. mortising length	177 mm+bit Ø
Max. clamp vise opening	190 mm



Optional bits

Sharing the same tool-holding shaft.
Easily interchangeable.

1640138 Set of 5 carbide bits
Diameters: 18, 21, 23, 25, 30 mm (ref. 1640138)

(*) Bit included with standard equipment.

- 1640127 Carbide bit Ø 16 mm*
- 1640150 Carbide bit Ø 17 mm
- 1640128 Carbide bit Ø 18 mm
- 1640367 Carbide bit Ø 20 mm
- 1640129 Carbide bit Ø 21 mm
- 1640378 Carbide bit Ø 22 mm
- 1640130 Carbide bit Ø 23 mm
- 1640368 Carbide bit Ø 23.5 mm
- 1640131 Carbide bit Ø 25 mm
- 1640369 Carbide bit Ø 29 mm
- 1640132 Carbide bit Ø 30 mm
- 1640140 Drilling bit

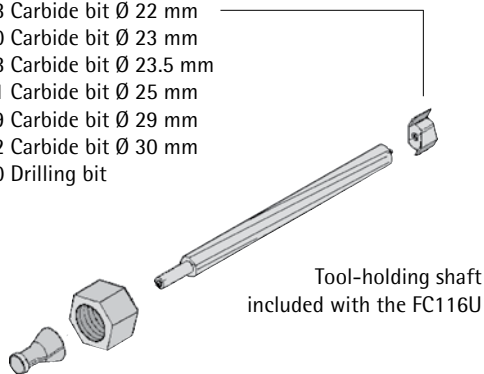

The clamp extension UP16I allows to fix the machine also on both ends of the door.



The accessory UT16I allows to take references for drilling the hole for the handle and key cylinder.



Optional accessories

- 1645287 UP16I Clamp extension
- 1645288 UT16I Drilling accessory
- 1640148 Carb. drilling bit* 2 c. Ø 18 mm **A**
- 1640149 Carb. drilling bit* 2 c. Ø 23 mm **B**

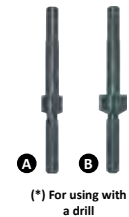

UC16K | Lock mortising template holder

UC16K is designed for making frontal and lateral recesses for any kind of lock on doors and frames. Designed for use with the router FR66P or FR160P, it is especially recommended for making recesses for locks that open with magnetic anti-panic cards and special opening devices. Its exclusive attachment system by means of clamp vises enables the user to mortise doors that have already been hung without damaging the surface. Secure, reliable grip. Works horizontally also. UC16K includes a height bar, making possible identical recesses on several doors at the same height, with no need to readjust the lock mortising template holder.



Specifications

Work area on door front: 80 x 300 mm.
Work area on door edge: 55 x 300 mm.
Maximum opening of clamp vises: 190 mm.
Maximum grip of clamp vises: 13 mm.
Maximum trimming depth: 60 mm.

Standard equipment

Set of templates, template guide for (FR66P /FR160P) and service keys.

Optional bits

1640157 Carbide bit Ø 12 mm (for FR66P)
1640258 Carbide bit Ø 12 mm (for FR160P)
(see page 48)



Additional sets may be ordered separately
(ref. 1645365)



Making side holes for placing the knob, cylinder or other mechanisms.

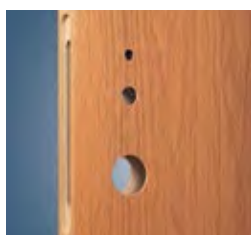

Using UC16K together with FR66P enables the user to quickly make recesses of exceptionally high quality.



UC16K gives extraordinary results on frames too.



Using UC16K with the FR66P enables the user to make recesses for the box-staple or lock and the holes for the latch and lever

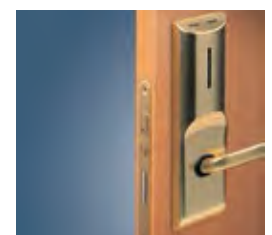

The UC16K is necessary when placing magnetic card locks, anti-panic locks and other special kind of locks.



PB83E | Template for placing door frames

The template is designed to facilitate the fast and perfect placement of frames and butt straps in doorsteads, securing them by means of polyurethane foam. The frames and butt straps can be placed in new or old doorsteads, and the existing door can be used in the latter case. The use of polyurethane foam guarantees total durability, making the door extremely robust. It sets fast (in under 10 minutes), enabling rapid work and optimum use of the available time.



Long lasting fixation thanks to the polyurethane foam.



Double door kit ref. 8345175.

Optional accessories

8345175 Extension for placing frames and butt straps in doorsteads for double or special sized doors.

Width from 1,240 to 1,640 mm

Many different door sizes

The template supports a wide range of door sizes, based on standard UNE 56802.

Door sizes supported:

Height from 1,905 to 2,160 mm

Width from 620 to 1,020 mm

Depth from 35 to 45 mm

Fast setting



Adjustment of measurements on the PB83E in function of the door to be placed.

For cutting the old frame we recommend our cutting machine model RM95R.

Anyway the cut can be also made by mean of any other kind of saw or manual tool.

In the case of new constructions, this process is not necessary.



Securing the frames to the template.

Easy placement



Placement of the PB83E, flush with the doorstead.

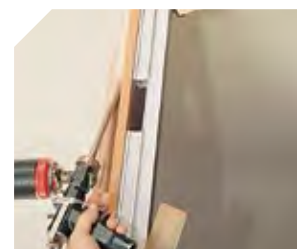

Filling with polyurethane foam.



Placing the butt straps using the stops provided.

It is not necessary to change the settings of the PB83E when removing it from the finished door. This means that we can fit as many doors as required with the same measurements.

Profile of finished door

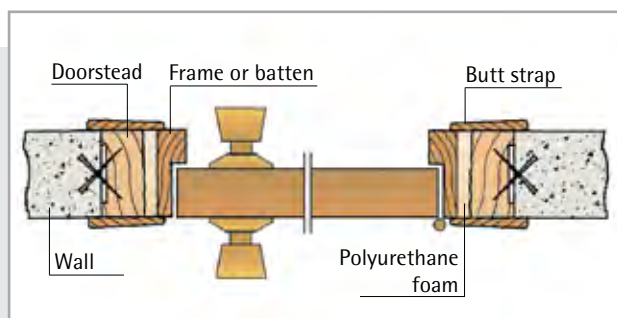

Video



RZ270S | Trimming machine

Specially designed for cutting doors, door frames, base boards and skirtings, it is ideal for installers of parquet or such other floor coverings as carpets, ceramic tiles, etc. Equipped with a powerful motor it provides a clean and precise cut easily and quickly. The cutting height and depth are adjustable by means of its milimetric gauges. Its cutting depth allows to cut the doors at once. Includes dust collection nozzle and pipe for connection to an external dust collector.



It cuts door frames without to disassemble the buttstraps, providing a precise and clean cut.



Its cutting depth allows it to cut the doors at once without splintering.



High fiability when cutting base-boards or skirtings.



Thanks to the possibility to take away the front part of the head it is possible to arrive to the corner when cutting the skirtings.



Cutting a shadow joint.



Standard equipment

Carbide saw blade Z 24 Ø 165 mm for cutting doors and skirtings (ref. 7040314), dust collection pipe 2.25 m long, carrying case and service keys.



Optional saw blades

7040193 Diamond disc (Ø 150), for cutting bricks, concrete, granite, ceramics and stoneware
7040316 Saw blade for cutting metals (Ø 165, Z 30), ideal to cut the metal sheets on the armored dors

Specifications

Input power	1,300 W
Cutting depth	0-47 mm
Minimum cutting height	8 mm
Maximum cutting height	35 mm
No-load speed	5,000/min
Weight	5.6 kg





FR817T | Corner trimmer

Specially designed for trimming on the corners on the polishing of solid wood parquet or stairs. It allows to trim the corners, where the traditional parquet sanders cannot arrive, leaving them at same level than the rest of the floor. Machine equipped with frontal protector avoiding damages to the skirting or any other wall elements. Includes a dust collection nozzle for connecting to an external dust collector.



It allows to trim the corners, where the traditional sanders cannot arrive.



Thanks to its design it can accede easily to the corners.



Easy and quick adjustment of the height of the bit.



Equipped with front protector to avoid to damage the skirtings or any other element fixed on the wall.

Perfect finishing
in less time

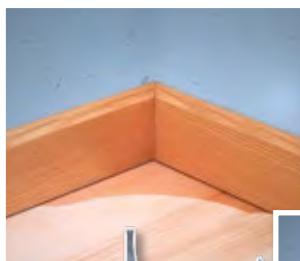

Standard equipment
90° carbide bit, service keys
and carrying case.



Specifications

Input power	750 W
No-load speed	14,000 - 30,000/min
Weight	1.9 kg



ATB40 | Cordless drill/driver

Compact, handy and lightweight cordless drilling and screwing machine for multiple jobs. Fast locking drill chuck. Change of the tool without the need for keys. Electronically adjustable work speed, also has 2 positions for different needs. Equipped with LED light for optimal lighting of the work area. It incorporates 2 original Li-Ion batteries and fast power charger. The battery is charged in only 1 hour.



Compact, powerful and easy to use.



Fast locking drill chuck.



Standard equipment

2 batteries, charger, double screw adaptor and carrying case.

Optional accessories

4040421 Low friction countersink with depth stop.
4040423 Drill bit for hinges with depth stop.



Led light for an optimal lighting of the work area.

SC324Y | Jig saw

Powerful, high precision professional jig saw equipped with a non slip handle. Clean splinter free cut. Electronic speed regulation and pendular movement with four positions. For wood, ferrous and non ferrous metals, plastic, materials, etc. Equipped with saw blade quick changing system and tiltable base from 0° to 45° for mitering cuts.



Base can be tilted from 0° to 45°.



Antisplinter cutting guide.



Standard equipment

Antisplinter cutting guide, plastic slide, set of 3 blades, dust collector connection and carrying case.

Optional accessories

6446073 Standard dust collector attachment 2.25 m

Saw blades
see page 81



Precise splinter free cut.

Specifications

Li-Ion battery	1,5 Ah
Battery voltage	12V
Torque	25/14 Nm
No-load speed	0-400 / 0-1400/min
Drill chuck	0,8-10 mm
Weight	1 kg



Specifications

Input power	650 W
Max. cutting depth (wood)	100 mm
No-load speed	500-3,000/ min
Base regulation	0°-45°
Weight	2.5 kg





SR165 | Circular saw

Provided with a powerful motor of 1,200 W. It can cut up to 51 mm depth. With riving knife and saw blade protection. Equipped with dust collector connection and carbide saw blade.



Light and stable, can make cuts of up to 51 mm.



Performing a mitre cut.

Saw blades
see page 81

Optional accessories
6446073 Standard dust collector attachment 2.25 m
9045705 UCP90 Cutting guide
7446879 Support for SR165



Equipped with dust collection connector.

Specifications

Input power	1,200 W
Saw blade diameter	153x20 mm
Cutting depth at 90°	51 mm
Cutting depth at 45°	34 mm
No-load speed	5,000/min
Weight	3.4 kg



SR90J | Circular saw

Easy to handle saw, long working service and safety in operation. This saw with its powerful 1,400 W motor can make cuts of up to 70 mm. Depth and cutting angle are adjustable. Equipped with a complete saw blade protection system with automatic return mechanism, dust collector connection and carbide saw blade.



Performs cuts of up to 70 mm.



Performing a mitre cut.

Saw blades
see page 81

Optional accessories
6446073 Standard dust collector attachment 2.25 m
9045705 UCP90 Cutting guide (support for SR90J already included)



Equipped with dust collection connector.

Specifications

Input power	1,400 W
Saw blade diameter	200x30 mm
Cutting depth at 90°	70 mm
Cutting depth at 45°	49 mm
No-load speed	5,800/min
Weight	6.2 kg





UCP90 | Cutting guide

The UCP90 guide allows to make straight cuts, giving a perfect guiding of the saw with total stability. It is adaptable to all the Virutex models of circular and jig saws.

Equipped from factory with two fixing systems, allowing a safe holding on the piece to work: two suction pads, for smooth and non-porous surfaces and a set of two clamp screws to be fixed on the lower side of the guide, even if the guide is longer than the panel.

The guide is also provided with non-slip strips to protect the panel from possible scratches.



Non-slip strips for a better fixing. They protect the panel from possible scratches.



The guide can be fixed by means of the two suction pads included (on smooth and non-porous surfaces).



Two clamp screws included for fixing the guide from the lower guide.

Circular saws + UCP90

Standard equipment

Guide 1400 mm long with adaptor for SR90J circular saw, 2 suction pads and 2 clamp screws.



The SR90J circular saw can be mounted on the cutting guide directly (adaptor not necessary). **(D)**



The SR74K circular saw can be mounted on the cutting guide by means of the optional support ref. 9045767. **(A)**

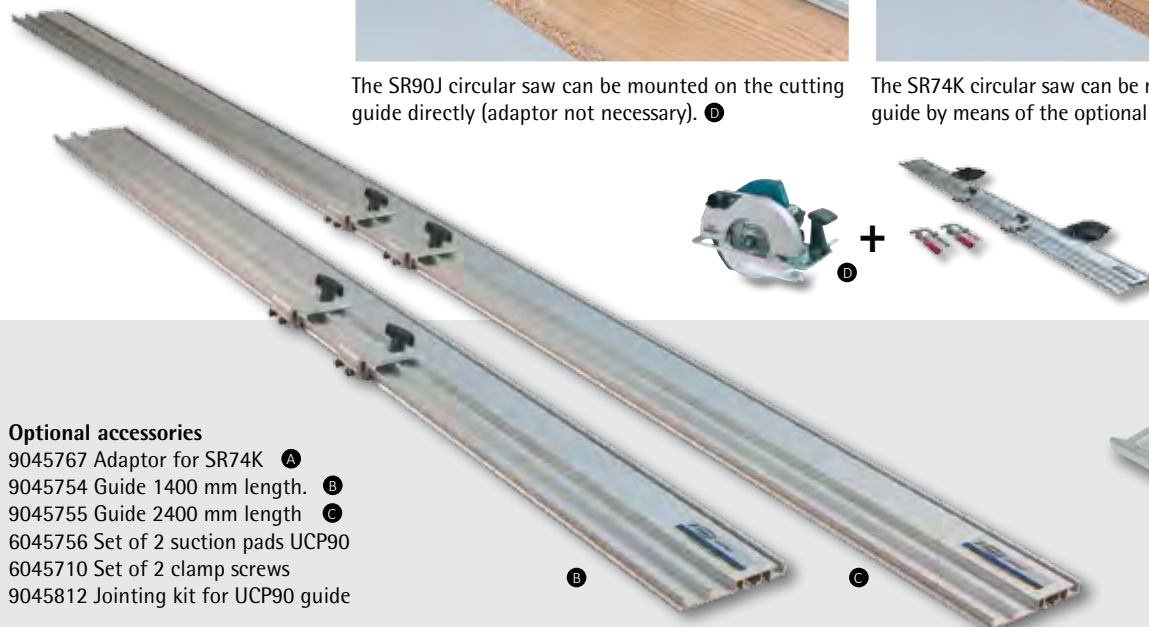

Optional accessories

- 9045767 Adaptor for SR74K **(A)**
- 9045754 Guide 1400 mm length. **(B)**
- 9045755 Guide 2400 mm length. **(C)**
- 6045756 Set of 2 suction pads UCP90
- 6045710 Set of 2 clamp screws
- 9045812 Jointing kit for UCP90 guide



Cutting guide not included as standard equipment.

SRI174T | Plunge-cut saw

Strong and ergonomic design. The saw glides directly on the guide without any additional accessory. Its powerful motor allows it to cut several kinds of materials. Automatic overload protection and soft start system for a smooth starting. Fast saw blade stop, soft grip rear handle, blocking lever for an easy change of saw blade and dividing knife adjustment. External dust collector connection.



Practical and precise depth adjusting system from 0 to 55 mm.



Precise gliding adjustment without lateral movement.



Allows to perform cuts at only 13.5 mm from a wall or any other vertical surface.

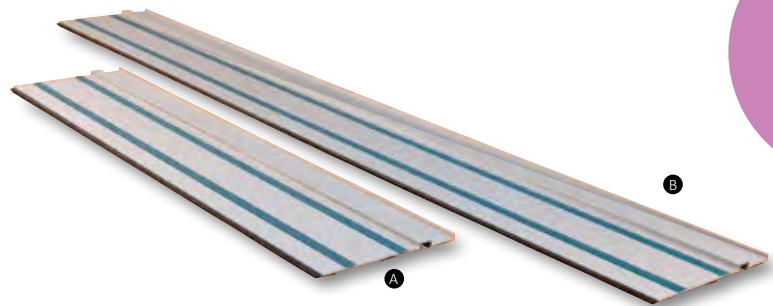

Optional accessories

- 7406518 UCP174T-800 cutting guide (800 mm) **A**
- 7406519 UCP174T-1400 cutting guide (1400 mm) **B**
- 7445818 Jointing kit **C**
- 7445819 Set of 2 suction pads (for smooth non porous surfaces) **D**
- 6045710 Set of two clamping screws **E**
- 6446073 Standard dust collector attachment 2.25 m



Standard equipment

Carbide saw blade Ø 160 mm Z28 for cutting wood and plastics. Dust collector nozzle. carrying case and service keys.

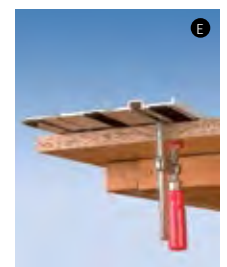
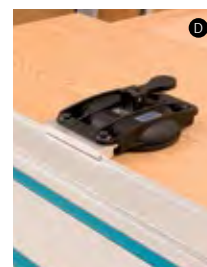
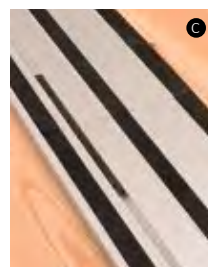

Specifications

Input power	1,150 W
Saw blade diameter	160x20 mm
Cutting depth at 90°	55 mm
Cutting depth at 45°	35 mm
No-load speed	5,500/min
Weight	4.7 kg



Optional saw blades

- 7440163** Carbide saw blade Ø 160x20 mm 28z universal for wood and plastics (included as standard)
- 7440327** Carbide saw blade Ø 160x20 mm 48z for laminates, Corian® and solid surface materials
- 7440328** Carbide saw blade Ø 160x20 mm 54z AD -5° for aluminium and plastic profiles

Corian® is a registered mark of DuPont.

TM33W | Mitre saw

High precision portable tiltable mitre saw. Equipped from factory with a carbide saw blade d. 300 48 Z. Big cutting capacity, up to 160x95 mm or 200x45 mm with the cutting head and base at 0°.

Easiness operation:

The gas buffer, soft starting system and the double transmission by belts, without gears noise, grant a high level of comfort and consequently an increase of the cutting precision and the quality of the work to be done.

Safety system:

The TM33W is equipped with a patented saw blade brake, stopping the saw blade few seconds after to switch off the machine, safety system against unintentional switch on, full saw blade protection and nozles for external dust collection.



New upper table, more surface for auxiliary works. Cutting capacity adjustable from 0 to 55 mm. Frontal rule for an easy cutting work. Possibility to adapt a fence (optional) for cutting angles (see page 76).

Video



Smooth movement thanks to the new powerful gas buffer.

Standard equipment

Professional carbide saw blade Ø 300 mm 48 Z, length cutting guide and service keys.



Equipped with a precision laser for guiding the cut. Automatic switch on when the machine starts. With a on/off switch to disconnect it when working on the upper table. The laser device is directly assembled on the saw blade, so the laser beam keeps its precision in any cutting position.



Electronic circuit protecting the machine against unintentional switch on due to a power supply lack. It also allows the soft start of the machine, without sudden jerks, avoiding breakdowns on belts or motor.



New upper table adjustment by cranted system. Gives a precise and smooth adjustment.



Ergonomic handle height adjustable for a more comfortable working position. Special switch protection against the dust.

Easy change of saw blade thanks to the blocking button. Equipped from factory with a carbide saw blade d. 300 mm 48 Z.



TS33W

Mitre saw similar to model TM33W, but without upper table.

Optional accessories for TM33W and TS33W



7246098 Fence (only for TM33W)



3345416 Pressers set



3346388 Set of supplements for cuts up to 200 mm.



5800100 Movable working table MT58K. Adjustable height up to 4 different levels. It is possible to carry on the MT58K with a mitre saw fixed on its top.

6446073 Standard dust collector attachment 2.25 m (for upper table)

3345470 Set of lateral handles for easy carrying on.

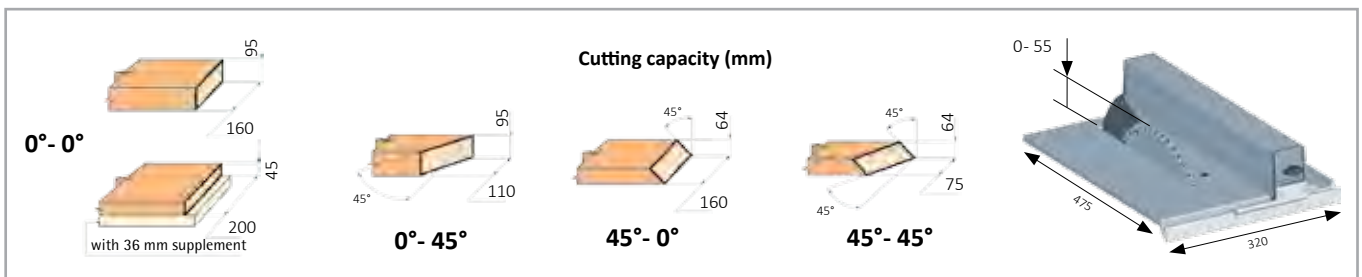

Specifications

Input power	1,500 W
No-load speed	3,700/min
Saw blade diameter	300 mm
Lower table guide*	57 mm
Weight	20 kg

*As per EN-61029 standards



Saw blades see page 81

TM433WTC | Transportable mitring centre

The TM433WTC is transportable. It is equipped with adjustable extensions for long pieces and very practice for working and carrying on. It allows an easy access into lifts and to go up and down stairs. Width 61.5 cm.

Standard equipment

The TM433WTC equippes a carbide saw blade 48Z, 2 lateral extensions for long pieces and 1 AngleCopy TC133R together with the table.



High working comfort when cutting long pieces, thanks to the extensions adjustable on each cutting side.



TS48L

Tiltable mitre saw similar to TM43L model but without upper table.

TM43L | Mitre saw

Tiltable mitre saw. Highly versatile performing mitres, bevels and combination mitre cuts. With upper table and dust collector connection.

Integrated safety system with saw blade brake and protection against intempesitive switch on.



Base is one block giving a large supporting area. A new table with nongrip turning system.



Equipped with a safety mechanism against accidental lowering of the cutting head.



The height of the handle can be adjusted for greater comfort.

Standard equipment

Professional carbide saw blade Ø 250 mm 40 Z, length cutting guide and service keys.



Upper table with guide and riving knife. Ideal for piece work and adjustments. Total protection from the blade.



Optional: Pressers set (code 3345416).



Optional: Set of lateral handles for easy carrying on (code 3345470).

Optional accessories

3345416 Pressers set
3345470 Set of lateral handles
7246098 Square for table (pag. 76)
6446073 Standard dust collector attach. 2.25 m (for working on upper table)
5800100 MT58K Portable table

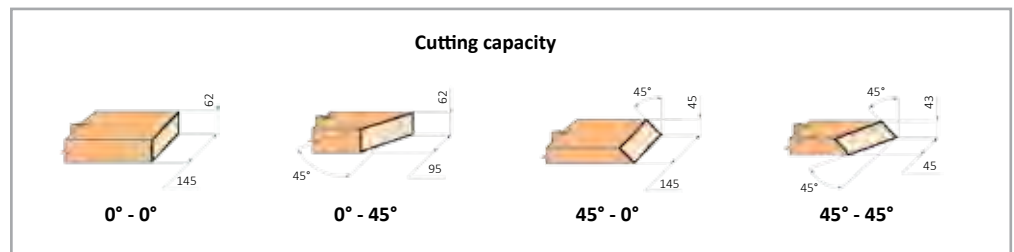

Saw blades

see page 81

Specifications

Input power	1,100 W
No-load speed	5,500/min
Saw blade diameter	250 mm
Weight	18 kg



Cutting capacity

Head	Table	Capacity
0°	to 0°	62x145 mm
	to 45°	62x95 mm
45°	to 0°	45x145 mm
	to 45° left	43x45 mm

Max. cutting capacity on upper table: 40 mm
Upper table dimensions: 307x375 mm



TS72C

Mitre saw similar to model TM72C, but without upper table.

TM72C | Mitre saw

High precision powerful tiltable mitre saw. Cutting capacity up to 150 mm. Head can be tilted from 0° to 45°. Equipped with adjustable upper table including adjustable square. Integral safety system with saw blade brake and protection against intempesitive switch on. Connector for external dust collection. Powerful, precise and safe.



High precision: the machine is designed for high precision in any position.



The machine can be connected to the external dust collector.



Protection against accidental lowering of the head. Total protection against mains cut off.

Standard equipment

Professional carbide saw blade Ø 300 mm 48 Z, length cutting guide, square guide and service keys.

Optional accessories

7500092 Pressers set
6446073 Standard dust collector attach. 2.25 m (for working on upper table)
5800100 MT58K Portable table



The TM variations include an upper table for auxiliary works.



Head can be tilted from 0° to 45°. The machine head can be turned from 0° to 45°.



Optional: Pressers set (code 7500092).

Electrical versions

TM72C: 220V, 1200W, Single phase, with upper table
TS72C: 220V, 1200W, Single phase, without upper table
TM73C: 220/380V, 1300W, 3-phase, with upper table
TS73C: 220/380V, 1300W, 3-phase, without upper table

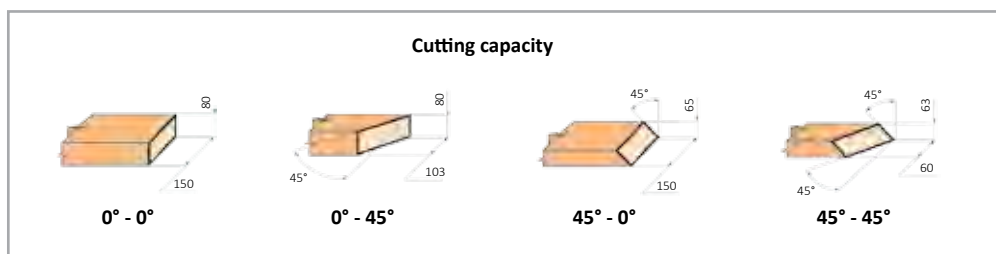

Saw blades

see page 81

Specifications

Input power	1,200/1,300 W (depending on version)
No-load speed	3,000/min
Saw blade diameter	300 mm
Weight	30 kg



Cutting capacity

Head	Table	Capacity
0°	to 0°	80x150 mm
	to 45°	80x103 mm
45°	to 0°	65x150 mm
	to 45° left	63x60 mm

Max. cutting capacity on upper table: 35 mm.

Upper table dimensions: 340x417 mm

Mitre saw

Aluminium + PVC + Wood



TM233W | Mitre saw

High precision portable tiltable mitre saw. Big cutting capacity, tilting head from 0° to 45°. Equipped with upper table, carbide saw blade 72 Z for aluminium and presser set. Integral safety system with saw blade brake and protection against interpestive switch on. Connection for external dust collection. Includes shut-off button for easy change of saw disc. No noise from gears: belt transmission with safety tension.

Optional accessories

3345470 Set of lateral handles, 3346388 Set of supp. cut 200 mm, 6446073 Standard dust collector attach. 2.25 m (for upper table), 5800100 MT58K Portable table, 7246098 Square for table.

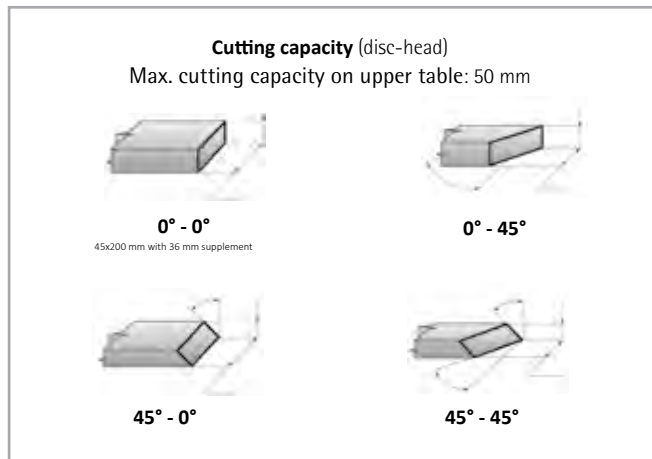

Saw blades
see page 81

Specifications

Input power	1,500 W
No-load speed	3,700/min
Saw blade diameter	300 mm
Weight	19 kg



Aluminium + PVC



TS233W | Mitre saw

High precision portable tiltable mitre saw. Big cutting capacity, tilting head from 0° to 45°. Equipped with carbide saw blade 96 Z for aluminium and presser set. Integral safety system with saw blade brake and protection against interpestive switch on. Connection for external dust collection. Includes shut-off button for easy change of saw disc. No noise from gears: belt transmission with safety tension.

Optional accessories

3345470 Set of lateral handles
3346388 Set of supp. cut 200 mm
5800100 MT58K Portable table

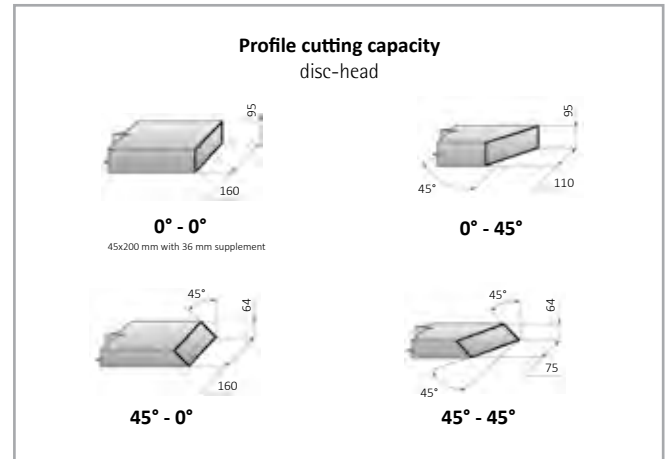

Saw blades
see page 81

Specifications

Input power	1,500 W
No-load speed	3,700/min
Saw blade diameter	300 mm
Weight	19 kg



MT58K | Movable working table

Height adjustable, transportable and folding, the MT58K gives a solid working surface where is possible to fix the machine. It can be moved and folded with the machine fixed on it, avoiding to fix and take out the machine continuously.

Working height: 810, 734, 621 or 383 mm
Table dimensions: 600x450 mm
Max. supported weight: 100 kg



Just press the elevation rod by foot and fix the height regulator by hand.



It is possible to carry on the MT58K with a mitre saw fixed on its top.



Adjustable height up to 4 different levels.

Optional accessories for MT58K

TEX58Z | Extendable stopper

Specially designed for mass-cutting of long pieces.

Extendable telescopic guide with double locking, end stopper and rule. Intermediate and end stoppers with rule in millimetres. Intermediate support roller aligned with the mitre saw. Solid and stable structure. Foldaway and easy to carry.



5845325 Extension foot MT58K (u.)

The optional extension 5845325 can be fixed on each side of the table, allowing to work with long pieces in a comfortable way. It is equipped with a roller for easy moving the working piece.

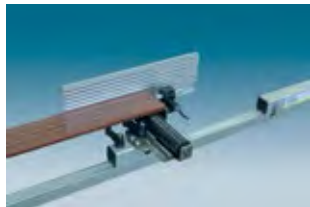

High cutting precision.

Specifications

Cutting length (section 1): 0 - 1,360 mm
Cutting length (section 2): 1,360 - 2,250 mm
Weight: 5 kg



TC133R | AngleCopy, angle copier

AngleCopy gives the correct angle when making mitering cutters. Without to take measurements and without to loose time making complicate calculations, AngleCopy is very practice for copying angles different than 90°.

When copying the desired angle with AngleCopy, the cutting guide divides the angle in two, giving the exact position for the miter cut. It is also provided with a small knob to fix the copied angle

and to avoid mistakes when transferring the angle to the machine.

Placing the AngleCopy parallel to the piece and cutting with the saw parallel to the angle marked by the cutting guide, a perfect miter cut is obtained. All the process without to take measurements or to make any calculations, obtaining a perfect result in an easy and fast way. And without any possibility to make mistakes. AngleCopy is com-

patible with all the miter saws for wood or metal of the market. It is possible to use it for internal or external angles and also can be used to mark the cutting angle on the piece with a pen or a hand saw. Its perfect simmetry allows to mark the cutting on both pieces to be cut.

AngleCopy makes easier several carpentry, building or a lot others jobs. It is specially designed for professional use.

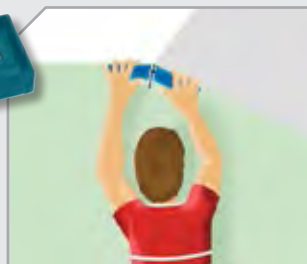

Easy copy of the angle.



Provides an exact cut, just placing the saw blade parallel to the cutting guide.



Perfect results in a few time.

Tools

Saw blades

Circular saws		Models
For wood, chipboards and plastics. Carbide. Ø 153x20x2,5 12z Ref. 7440092		SR74K
For wood, chipboards and plastics. Carbide. Ø 153x20x2 24z Ref. 7440196		SR74K
For chipboards and plastics. Carbide. Ø 160x20x2,8 28z Ref. 7440163		SRI174T
For laminates, corian and solid surface materials. Carbide. Ø 160x20x2,6 48z Ref. 7440327		SRI174T
For aluminium and plastic profiles. Carbide. Ø 160x20x2,6 A.D.NEG. 54z Ref. 7440328		SRI174T
For wood, chipboards and plastics. Carbide. Ø 165x20 24z Ref. 7440419		SR165
For wood, chipboards and plastics. Carbide. Ø 200x30x2,5 20z Ref. 9040154		SR90J
For wood, chipboards and plastics. Carbide. Ø 200x30x2,7 30z Ref. 9040155		SR90J

Para tronadoras		Modelos
For wood, chipboards and plastics. Carbide. Ø 250x20/30x3,2 40z Ref. 4340082		TM43L TS48L
For wood, chipboards and plastics. Carbide. Ø 300x20/30x3,1 48Z Ref. 9040068		TM33W TS33W

Circular saws		Models
For wood, chipboards and plastics. Carbide. Ø 300x30x2,8 48z Ref. 7240188		TM72/73C, TS72C, TS73C TM33W, TS33W
For chipboards and aluminium and plastic profiles. Carbide. Ø 300x30x3,2 72z A.D.0 Ref. 9040069		TM72/73C, TS72/73C, TM33W, TS33W TM233T
For aluminium and plastic profiles. Carbide. Ø 300x30x3,2 96z A.D.neg. Ref. 3340319		TM72/73C, TS72/73C, TM33W, TS33W TS233T
For varnished mouldings. Carbide Ø 300x30x2,7 96z Teflon Ref. 3340190		TM72/73C, TS72C, TS73C TM33W, TS33W



Various		Models
Carbide blade Ø 100x4 , 2 teeth & 2+2 spurs Ref. 1440080		AB111N
Carbide blade Ø 100 inner shaft. Ø 22 Ref. 1440382		AB111N
CA64B, Carbide bit for repairing resin pockets on wood Ø 100 MD Ref. 6440376		AB111N
For armored doors Ø 160 Ref. 7040194		RZ70M RZ170N
For wood, chipboards and plastics. Carbide. Ø 165 24z Ref. 7040314		RZ270S
For armored doors Ø 165 Ref. 7040316		RZ270S

Tools

Saw blades

Various

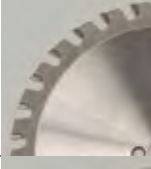
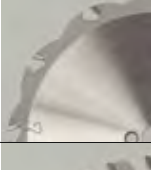
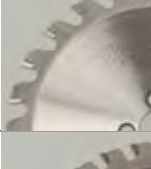
Models

Diamond Ø 180 Ref. 7040329		RV70S, RV70U
For wood Carbide Ø 200 30z Ref. 7040330		RV70S, RMV70S, RV70U, RMV70U
For wood Carbide Ø 200 12z Ref. 7040371		RV70U, RMV70U
For wood, chipboards and plastics. Carbide. Ø 160 24z Ref. 7040182		RZ70M, RZ170N
For wood Ø 200 18z Ref. 7040415		RMV70S, RV70S, RV170S, RMV70U, RV70/170U

Jig saw blades

Ref.	Description
3440095	Fine cut, for soft and hard wood up to 60 mm. (HCS, pitch 4 mm, length 75 mm)
3440167	Fine cut, for soft and hard wood up to 80 mm. (HCS, pitch 4 mm, length 105 mm)
3440094	Curved cut, for soft and hard wood up to 60 mm (HCS, pitch 4 mm, length 75 mm)
3440093	Very fine cut, for soft, hard wood and chipboard up to 30 mm (HCS, pitch 2.5 mm, length 75 mm)
3440163	Very fine cut, for soft, hard wood and chipboard up to 30 mm (HCS, pitch 2.5 mm, length 105 mm)
3440097	Very fine cut, for soft, hard wood and chipboard up to 80 mm. For linoleum and flexible plastics up to 8 mm (HCS, pitch 4 mm, length 105 mm)
3440164	Very fine cut, for soft, hard wood and chipboard up to 80 mm. For linoleum and flexible plastics up to 8 mm (HCS, pitch 4 mm, length 105 mm)
3440096	Rough cut, for soft and hard wood up to 60 mm. For expanded polyurethane up to 40 mm (HCS, pitch 3 mm, length 75 mm)
3440098	For soft steel up to 3 mm. Aluminium and non ferrous metals up to 4 mm. Melamine and synthetic fibres up to 8 mm (HCS, pitch 1.2 mm, length 52 mm)
3440165	For soft steel up to 3 mm. Aluminium and non ferrous metals up to 4 mm. Melamine and synthetic fibres up to 8 mm (BIM, pitch 1.2 mm, length 105 mm)
3440099	For soft steel up to 6 mm. Aluminium and non ferrous metals up to 8 mm. Melamine and synthetic fibres up to 10 mm (HSS, pitch 2 mm, length 52 mm)
3440166	For soft steel up to 6 mm. Aluminium and non ferrous metals up to 8 mm. Melamine and synthetic fibres up to 10 mm (BIM, pitch 2 mm, length 105 mm)
3440100	For soft steel up to 6 mm. Aluminium and non ferrous metals up to 8 mm. Cement fibres and synthetic materials up to 10 mm (HSS, pitch 3 mm, length 52 mm)

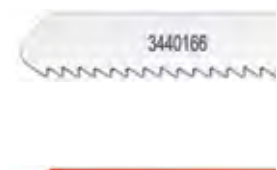
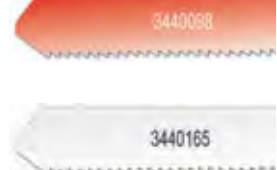
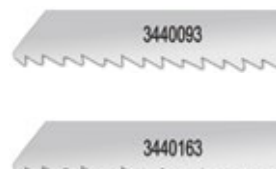



AS182K / AS282K / AS382L | Dust collectors

Professional dust and liquid collectors. Specially designed for connecting machines and power tools. Thanks to their power they allow to work in more comfortable and safety conditions. Provided with a socket for power tools connection they have a special switch on system which activates the dust collector when switching on the tool plugged in it, and stops it some seconds later than the tool. Equipped with double pipe connection allowing to connect two machines at once.

The model AS382L is equipped with two motors and has a high suction power.



The AS182K dust collector is easily transportable.



Double filter system for micro-particles.



Possibility to connect two machines at once.

Optional dust bags

10 bags for AS182K (ref. 8299682)
5 bags for AS282K and AS382L (ref. 8299683)



Socket for connecting power tools.



The AS282K and AS382L dust collectors have a big capacity container.



Dust collector kit ref. 8246233 (Optional)*

Pos.	Ref.	Denomination
1	8299157	Flexible pipe 2 m
2	8299158	Brush
3	8299159	Nozzle for liquids
4	8202131	Nozzle for grooves
5	8299092	Round brush
6 Et 7	8202316	Pipe
8	8202317	Articulated pipe
9	8202134	Triangular nozzle



Optional accessory

8299173 "Y" connector for AS382L (Included as standard on models AS182K Et AS282K)

(*) The dust collector kit ref. 8246233 is included as standard with models AS182K and AS282K.

Specifications

Input power AS182K and AS282K	1,200 W	Air delivery AS182K and AS282K	170 m ³ /h
Input power AS382L	2,300 W	Air delivery AS382L	340 m ³ /h
Container capacity AS182K	27 l	Socket for power tools connection max.	2,600 W
Container capacity AS282K and AS382L	72 l	Cable length	8 m
Cooling	by-pass	Polyester filter included	
Water col. vac. (H2O)	2,200	Special filter for fine dusts included	



Model available only in Spain.

ASC682 | Compact dust collector

Strong and compact professional vacuum cleaner for dust and liquids, specially designed for connecting power tools. Thanks to its high suction power it allows to work in more comfortable and safety conditions. Provided with a socket for connecting the power tools it has a electronic switch on system wich activated the vacuum cleaner when switching on the tool plugged in it, and stops it some seconds later than the tool, to allow thw vacuum cleaner to vacuum the remaining dust on the tool and the pipe. Electronic adjustment, specially suitable for rotary orbital sanders to avoid the possibility they can remain stuck to the workpiece when sanding, due to the suction power.

Standard equipment

Flexible pipe, filter for dust, filter for liquids, 1 paper dust bag.



Double filter for microparticles. Automatic shaker for filter.

Optional accessories

8245979 "Y" connector
8245847 Dust collector kit

Optional dust bags

8299684 10 paper bags for AS482U
8299575 Felt dust bag for AS482U



Dust collector kit ref. 8245847 (Optional)

Pos.	Ref.	Denomination
1	8299158	Brush
2	8299159	Nozzle for liquids
3	8202131	Nozzle for grooves
4	8299092	Round brush
5 Et 6	8202316	Pipe
7	8202317	Articulated pipe
8	8202134	Triangular nozzle

Specifications

Input power (electronic adjustment)	1,200 W
Socket for power tools connection max.	2,200 W
Container capacity	25 l
Air delivery	240 m ³ /h
Max. depression mm (H ₂ O) 2.500	250 mbar
Weight	13 kg



ASM582T | Dust collector M class

Dust collector for all kind of dust, wooden chips or non dangerous mineral materials. Filter "M" class for mineral and wooden dust MAK>0,1 mg/m³. Equipped with automatic filter shaker.

Thanks to its high suction power it allows to work in more comfortable and safety conditions. Provided with a socket for connecting the power tools it has a electronic switch on system wich activated the vacuum cleaner when switching on the tool plugged in it, and stops it some seconds later than the tool, to allow thw vacuum cleaner to vacuum the remaining dust on the tool and the pipe.



"M" class filter with automatic shaker.



Socket for connecting power tools.

Standard equipment

Flexible pipe and polyester dust bag.

Optional accessories

8299656 "Y" connector
8299685 Paper bag
8245847 Dust collector kit

Specifications

Input power	1,400 W
Socket for power tools connection max.	2,400 W
Container capacity	21 l
Air delivery	215 m ³ /h
Weight	12 kg

System for connection to dust collectors

AS182K / AS282K / AS382L / ASC682 / ASM582T



TM72C/TS72C
TM172T/TS172T



(1)

TM33W/TS33W
TM233T/TS233T



(1)

TM43L/TS48L



(1)

CE24E



CE120P



GR120P



CE35E



CE89E

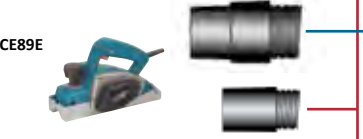

CE96H



CE53S



AS182K, AS282K,
AS382L, ASC682 &
ASM582T



6446073

Standard dust collector attachment 2.25 m with 4 brackets for fixing the cord.

8299077

Dust collection pipe (included on AS182K, AS282K and AS382L as standard equipment).

8299567

Dust collection pipe (included on ASC682 as standard equipment).

8299658

Dust collection pipe (included on ASM582T as standard equipment).

(1)

For connection to the lower protection when working on the upper table.



RM95S/RMV70U
RV70U



LR46L
LRE46L



LRT84H
LR84H
LRE84H
LR184N



RTE84H



RTE146L
RTE46L



RT188N



LB31E
AF11



AB111N
AB181



RA17VG
RA17VB
FR156N
FR256N



FR66P
FR160P
FRE160P
FRE317S



FR277R
FR278R



FR98H



CE23N/CE123N



FR817T FR217S



LPM97S LPC97S



FC116U



ST62



SC324Y



SR90J



SR165/SR74K/SR1174T



U78 | Mitering cutter

Mitering cutter for adjusting plastics, laminates and veneer. Its precise cut gives unequalled perfection. Useful for covering drawers, cupboard fronts, tapetes, etc.



Perfect cut.



Precision finish.



CO15L | Laminate cutter

Strip cutter for laminates, quick and easy to use. With it you obtain a clean splinter-free cut with no waste. Cuts plastics, laminates and veneer. Cutting depth can be adjusted with micrometric measure and it has a guide on a millimeter scale for easy adjustment of strip width.



Clean splinter-free cut with no waste.



Micrometric regulation of the cutting width.



TK78 stand for securing to a workbench.

Blades

1527075 Set of 2 wheel blades

Optional accessories

1550000 TK78 stand

Specifications

Cutting depth to 90°	145 mm
Cutting width to 45°	90 mm
Max. cutting depth	1.8 mm
Weight	7 kg

Specifications

Cutting width	12-110 mm
Cutting depth	0-2 mm
Weight	1.2 kg



CO49K | Automatic slitter

The CO49K automatic slitter is the result of the experience of Virutex as manufacturer of laminate cutting machines. It allows to cut strips from laminate, plastic, veneer and other light non metallic materials. Its feeding system, by mean of motorized rubber rollers and the exclusive cutting system by wheel blades, allows clean splinter free cuts. It is possible to work with laminate sheets of any dimensions, thanks to its well dimensioned table giving a good stability for having perfect cuts. No additional work is required. Equipped with wheel spacers, special for laminates. It is also equipped with a movable cutting guide and a scale for an easy adjustment of the cutting wide.



Easy to regulate, easy to mantain.



Easy adjustment of the cutting wide.



It is possible to work with laminate sheets of any dimensions, thanks to its well dimensioned table giving a good stability for having perfect cuts.

Optional accessories
5800100 MT58K movable working table

Blades
1527075 Set of 2 wheel blades



Specifications

Input power	180 W
Feeding speed	13.6 m/min
Max. cutting thickness	1.6 mm
Minimum cutting length	185 mm
Regulable cutting width	16-635 mm
Weight	44 kg



L100/L160 | Laminate presser rollers

Designed for strengthening the glued surfaces. It allows to make an homogeneous pressure on the glue, to prevent the formation of air pockets. Available in two models with roller of 100 mm or 160 mm length.



Easy to use

Ref. 2546439 with roller 100 mm length
 Ref. 2546440 with roller 160 mm length



MC3 | Mitring cutter for PVC profiles

Designed for cutting all kind of PVC profiles for windows and roller blinds. It allows to adapt the profiles on length, width or even to perform mitre cuts at any angle in an easy and fast way. The PVC profile cutter needs no maintenance. It is compact and easy to carry.



Performing a mitre cut.



Fast and clean cutting without any risk. No dust nor static PVC chips.

Video



Specifications

Dimensions	L 370 x l 270 x h 220 mm
Weight	8.5 kg



EM25D/EM26D | Hand gluer

Hand gluer for gluing large surfaces using vinyl glue (white glue). Equipped with trigger shut-off device to stop the flow of glue. Also comes with a support where it can be left when not in use, thus keeping the working area and the machine clean. Gluing roller width: 122 mm. The model EM25D is equipped with an auxiliary upper roller for clean gluing strips.



Gluing with vinyl (white) glues



Gluing with the upper roller.



EM125T/EM126T | Hand gluer

A range of hand gluers for gluing large surfaces using vinyl or synthetic glues (white glues). Equipped with trigger shut-off device to stop the flow of glue. Also come with a support where they can be left when not in use, thus keeping the working area and the machine clean. Gluing roller width: 180 mm. The model EM125T is equipped with an auxiliary upper roller for clean gluing strips.



Gluing with vinyl (white) glues



Gluing with the upper roller.

All models are equipped with trigger shut-off device to stop the flow of glue.

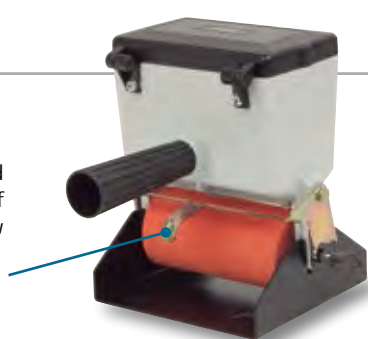

Rubber roller: for white glues and water-soluble emulsions. Amount of glue to be applied: MEDIUM.

Polyurethane roller: for synthetic resin glues, white glues, and water-soluble emulsions. Amount of glue to be applied: LITTLE. ^A

Specifications

Lower roller width	
EM25D-EM26D/EM125T-EM126T	122 mm/180 mm
Upper roller width	92 mm
Tank capacity EM25D-EM26D/EM125T-EM126T	1 kg/1.4 kg

Optional accessories

Model	EM25D / EM26D	EM125T / EM126T
Rubber roller	2504005* - 122 mm	2504279* - 180 mm
Polyurethane roller	2504065 - 122 mm	2504280* - 180 mm

* Included as standard equipment



SVN250



SVE350



SVN250 / SVE350 | Vacuum Clamping Systems

SVN250 model

Designed for connection to an external air compressor.

SVE350 model

Designed for connection to the electrical vacuum clamping system SVE600 (optional).

Firm fixation of pieces of smooth and non-porous surface by means of the pneumatic vacuum fastening system. Instant fastening and without leaving any marks on the surface of the pieces. It is possible to fix large or small pieces in different positions. The firmness of the fastening allows to work with comfort, freeing the professional of complex and uncomfortable fixings.

Its compact size makes it extremely versatile and practical, both for work inside the workshop and outside. It allows to divide the fixing panel in different configurations, with the set of 3 joints supplied with the equipment, so that it allows the subjection of small pieces or with different shapes. By using several units it is possible to fix large boards. The SVN250 or SVE350 must be fixed to the workbench by screws, through the holes that it is provided with.



SVN250: The connection to an external compressor is made through a quick connection tube.



Securing small pieces on a divided portion of the suction plate.



Fixed horizontally and vertically.



SVE350: The connection to the electrical vacuum clamping system (SVE600) is made through a quick connection tube.

Standard equipment

SVN250 and SVE350

With a rubber gasket already assembled, transparent tube with quick connector of 1/4" for air supply (only SVN250) and set of 3 rubber gaskets.

Optional accessories

For SVN250 model: Optional multiple connector (ref. 5046350) for connection to the pneumatic network.

For SVE350 model: Electrical vacuum clamping system SVE600 (includes SVE350).



Specifications

Clamping force (SVN250)	800 gr/cm ² at 6 bar
Working pressure (SVN250)	5,5-7 bar
Air consumption at 5.5 bar (SVN250)	28 l/min
Dimensions suction plate	150 x 150 mm
Dimensions of each unit	160 x 22 x 200 mm
Weight	325 gr

SVN450



SVE670

Video



SVN450 / SVE670 | Tilting fastening Systems

SVN450 model

Designed for connection to an external air compressor.

SVE670 model

Designed for connection to the SVE600 vacuum electric fastening system included in the original.

The SVN450 and SVE670 tilting fastening systems are formed by basic systems SVN250 (for model SVN450) and SVE350 (for model SVE670), mounted on a folding support. They allow the machining of the edge and face of the piece without changing clamping.

The SVN450 model incorporates an air distributor with four free outputs for the connection of auxiliary units SVN470 or SVN250, equipped with stopcock and quick connector to the pneumatic network.

The SVE670 model has a free socket for the connection of auxiliary units such as SVE680 and SVE350. Both models include a tightening clamp for fastening to the workbench and a set of three rubber gaskets of different perimeter.

Optional accessories

Ref. 0999102 Set of 4 screws for mounting an SVN250 or SVE350 (depending on model) on the base.



Models SVN450 and SVE670 with adjustable folding support.



Model SVN450 with four-way air distributor, allows the connection of SVN470 or SVN250 units.



Gripping large pieces with the help of an SVN470 auxiliary unit.



The SVE670 model allows the connection of an optional SVE680 or SVE350 unit.

Specifications

Holding force (SVN450/SVN470)	800 gr/cm ² at 6 bar
Working pressure (SVN450/SVN470)	5,5-7 bar
Air consumption at 5.5 bar (SVN450/SVN470)	28 l/min
Dimensions suction plate (all models)	150 x 150 mm
Power (SVE600/SVE670)	95 W
Vacuum pressure (SVE600/SVE670)	750 mbar

SVN470 / SVE680

Auxiliary fixing systems, ideal for holding large pieces. Tilting $\pm 90^\circ$ for efficient and ergonomic work of edges and surfaces.

Model SVN470, designed to connect to SVN450 or SVN460 models.

Model SVE680, designed to connect to the SVE600, SVE660 and SVE670 models.



SVN460



NEW

SVE660

SVN460 / SVE660 | Multiple Fastening Systems

SVN460 model

Diseñado para la conexión a un compresor de aire externo.

SVE660 model

Designed for connection to the SVE600 vacuum electric fastening system included in the original.

The multiple fastening systems SVN460 and SVE660 are formed by a basic system SVN250 (SVN450) or SVE350 (SVE660), mounted on a tilting and rotating support. They allow the machining of edges and face of the piece without changing clamping.

The SVN460 model incorporates an air distributor with four free outputs for the connection of auxiliary units SVN470 or SVN250, equipped with stopcock and quick connector to the pneumatic network.

The SVE660 model has a free socket for the connection of auxiliary units such as SVE680 and SVE350. Both models include a tightening clamp for fastening to the workbench and a set of three rubber gaskets of different perimeter.



Folding and rotary adjustable support.



It allows to place the piece in the ideal position



Attach large pieces thanks to an auxiliary unit SVN470 (SVN460) or SVE680 (SVE660).

Optional accessories

Ref. 0999102 Set of 4 screws for mounting an SVN250 or SVE350 (depending on model) on the base.

NEW



SVN470 / SVE680

Auxiliary fastening systems, ideal for holding large pieces. Tilting $\pm 90^\circ$ for efficient and ergonomic work of edges and surfaces.

SVN470 model, designed to connect to SVN450 or SVN460 models.

SVE680 model, designed to connect to the SVE600, SVE660 and SVE670 models.

Specifications

Clamping force (SVN460/SVN470)	800 gr/cm ² at 6 bar
Working pressure (SVN460/SVN470)	5,5-7 bar
Air consumption at 5.5 bar (SVN460/SVN470)	28 l/min
Dimensions suction plate (all models)	150 x 150 mm
Power (SVE660)	95 W
Vacuum pressure (SVE660)	750 mbar



NEW

SFV50 | Vacuum table

The vacuum table SFV50 is ideal for a quick fastening of the panel. Two clamp screws are included as standard equipment to fix the table to the workbench.

It is an efficient system to hold the panel and work in a comfortable way on all its edges. The vacuum table must be used with clean, smooth and non porous panels only.

It is possible to hold panels in horizontal or vertical position. Using several vacuum tables it is possible to hold larger panels.



It can be fixed to the workbench by means of the two clamp screws included as standard equipment.



Using two vacuum tables it is possible to hold larger panels.

Standard equipment

Set of two clamp screws L=100 (ref. 6045710) included



It is possible to hold panels in horizontal or vertical position.



QUICK T-TRACK | Automatic clamp

Flat head for inserting in slots of 12 x 8 mm.

Maximum strength 60 kg (600 N).

Head in nylon and fiberglass.

Templated carbon steel bar.

Plastic protectors included.

Free oils plastic shoes.

No traces left.

Easy to use with just one hand.



Ideal for fixing rails. Easy to use with just one hand.



Oil free plastic caps. No traces left.



Versatile in multiple applications.



SFV150

Vacuum table similar to SFV50, but with only one suction pad.

Standard equipment

1 clamp screw L=100



Specifications

Maximum strength

600 N / 60 kg

Weight

0,25 Kg



PT81U | Transport handle

Its handy and ergonomic design allows to carry panels in wood, metal, PVC..., up to 46 mm thickness in an easy way. It is composed of a solid aluminium body, two anti-slip skates and a handle, the PT81U is a strong accessory allowing to carry up to 70 kg each one.

3 fonctions: holding, carrying and lifting panels.



Holding panels



Carrying panels



Lifting panels

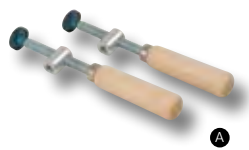

Optional accessory
Presser accessory (2 units) code 8145100, to transform the transport handles into a pair of double pressers PC81U. **A**

PC81U | Double presser

Strong aluminium body with anti-slip and anti-scratch skates for working with delicate panels. Double function: edges and angle presser. As edges presser is very easy to use on straight, concave or convex panels. Easy to transform into a panel transport handle just only changing the position of the handle.

3 fonctions: edges presser, angle presser and transport handle.

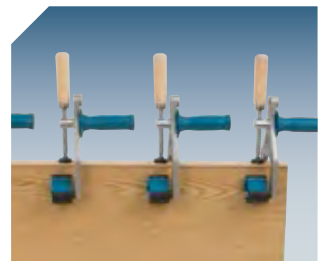

Fixing tapes on straight panels



Fixing tapes on concave panels

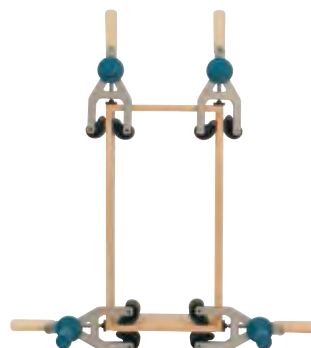

Fixing angles, assembly of a drawer

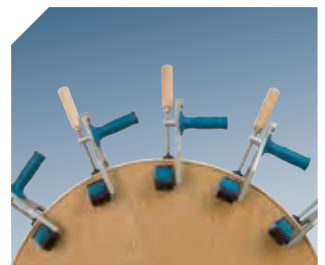

Fixing tapes on convex panels

Easy to transform into a panel transport handle just only changing the position of the handle

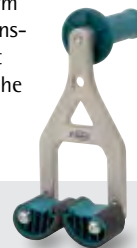

Specifications

Panel thickness	0-46 mm
Max. load per handle	70 kg
Weight (per unit)	0.50 kg

Specifications

Panel thickness	0-46 mm
Weight (per unit)	0.65 kg

Video



PMT111 | T multiguide

Forget all your old templates with this new multiguide. The PMT111 is an indispensable positioning guide for cabinetmaking, furniture manufacturing... Reversible precision multiguide. It allows all drillings pitch 32 mm on cupboards, wardrobes, etc...

- Door and drawer handles
- Brackets for shelves
- Hinges
- Guides for drawers and several other applications.



Drilling for drawers.



Drilling for door handles.



Drilling for door accessories.



Drilling for placing shelves.

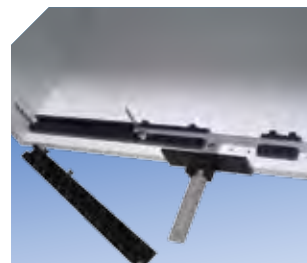

Several working possibilities.



Drilling for placing invisible hinges.

Other options

1146533 PMT111 T guide with extensions.

Drilling bit Ø 5 mm included on standard equipment



Optional accessories

1146516 Set of 2 extensions for PMT111

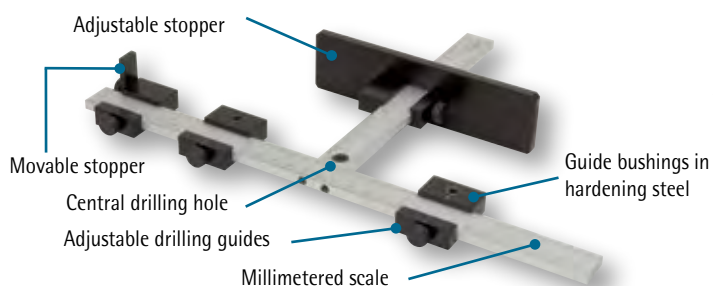

Set of two extensions for multiple drilling, pitch 32 mm

Specifications

Dimensions	L 320 x l 215 mm
Dimensions*	L 810 x l 215 mm
Weight	0.35 kg
Weight*	1.20 kg

(*) PMT111 with extensions

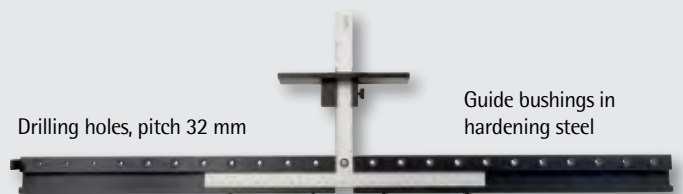



MR81B | Clamp vise

Ideal for carpentry works out of the workshop. Easily positioned on any table leaving no marks. Gives greater safety and precision in your work. Its advanced design allows you to position the pieces in several ways. Its exceptional solidity allows you to clamp metal pieces and carry out precision work.



Edgeworking, trimming and other kind of jobs.

RP80 | Roller presser

Roller presser adaptable to any panel saw. Gives more safety and comfort in work. Allows to keep the panel well pressed against the table of the machine. Ideal for thick panels (laminated, plexiglass...). It is advisable to use one unit on each side of the saw blade. Easy adjustment, the spring arm can be locked to limit the pressure when making the vertical adjustment.



PM11D | Multiguide

For jointing 16 and 19 mm boards using dowels (Ø 8 mm) or screws. High quality finish with no need for later adjustment. Any type of joint can be made, either square jointing or centre board jointing. Ideal for various professional uses such as: small jobs, making small orders, adjustments, repairs etc. The standard kit includes the following items: supplements for 16 mm boards, reducer screws and stop for drill bit.



This highly practical accessory makes joints quick and easy to perform with no time lost marking reference points.



For precise reliable final results giving perfect solid joints.



PD52X | Heat gun

The heat gun, with electronic temperature control, features two heat settings to accommodate a wide variety of jobs. It is the ideal tool for stripping paint and varnish. It's also suitable for shaping and welding plastics, removing decals, shrinking wire wraps, defrosting of water lines and more! This tool can work with the majority of accessories available on the market.

Standard equipment

Nozzle



Optional accessories

2546409 Gluing set SEM1



Specifications

Input power	1,500 W
Temperature	I: 300°C II: 525°C
Air delivery	400 l/min
Weight	0,75 kg

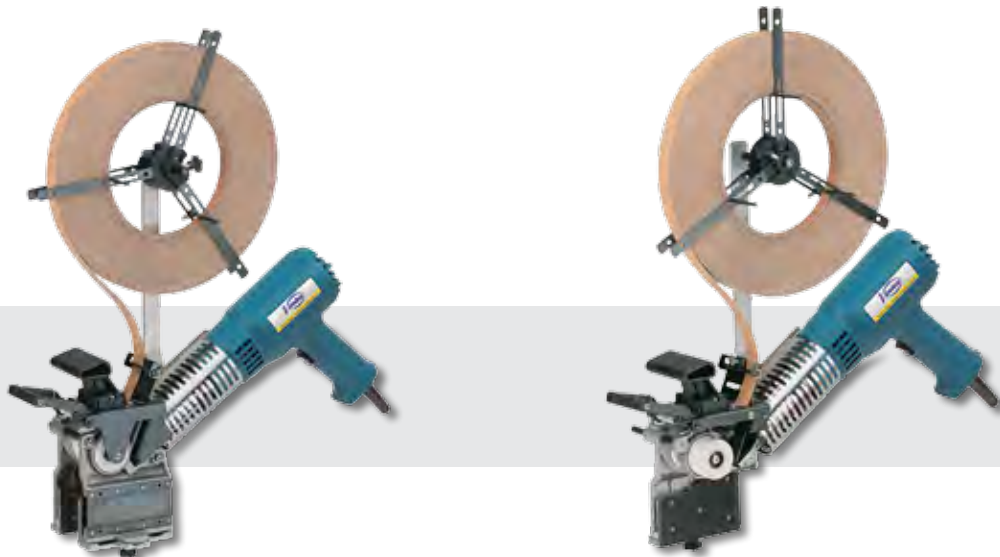

AG98F | Manual edgebander

For edgebanding preglued PVC, melamine and veneer. Enables banding of circular or shaped pieces. Its special design with adjustable clamps ensures high precision work with great stability. A practical edge trimming system included. The possibility of surface glueing or with excess on either of the two sides. Set up time: less than one minute.



High precision and stability during edgebanding.

AG98E | Manual edgebander

For edgebanding preglued PVC, polyester, melamine and wood veneer. For the same types of banding as the AG98F. When using the lap banding guide, included in the machine set, it is possible to band the internal sides of doors, grooves or jamb cut outs.



Banding the internal side of a lapped door.

Optional accessories

2800000 AU93 Edge trimmer
2100000 RC21E End trimmer
5246025 Roller inclined at 4° for edge-banding on inclined door surfaces, etc.



Enables banding of circular or shaped pieces.

Optional accessories

2800000 AU93 Edge trimmer
2100000 RC21E End trimmer
5246194 Roller at 4° specially designed for banding inclined surfaces on doors, etc.



Banding the upper side of the lap.



Clamping systems (see page 90-94)

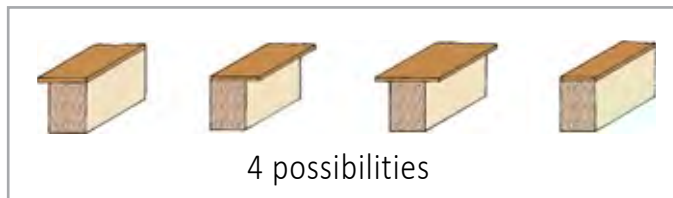

Specifications

Input power	1,500 W
Maximum banding width (1 mm thickness)	50 mm
Temperature	I: 300°C II: 525°C
Air delivery	400 l/min
Weight	2.7 kg



Specifications

Input power	1,500 W
Maximum rabbet width	40.5 mm
Minimum rabbet height	4.5 mm
Maximum banding width (1 mm thickness)	50 mm
Temperature	I: 300°C II: 525°C
Air delivery	400 l/min
Weight	2.7 kg





AG98R | Manual edgebander

For banding preglued PVC, polyester, melamine and veneer tapes. Enables to band circular or shaped pieces. Its special design with adjustable clamps ensures high precision work with great stability. Practical end trimming system included. Possibility to band flush with panel surface or with excess on either of both sides. Set up time less than one minute.

Two tape feeding systems:
 Holder for tape rolls up to 1 mm thickness and 50 mm width.
 Manual feeding for pre-cut strips up to 3 mm thickness and 25 mm width.
 It also includes as standard a roll holder for banding with rolls.



Easy to place the pre-cut strip.



High precision and stability during edgebanding.



Manual feeding for banding pre-cut strips up to 3 mm thickness and 25 mm width with high precision and stability.

Optional accessories

- 2800000 AU93 Edge trimmer
- 2100000 RC21E End trimmer
- 5600300 FR156N Trimmer
- 2100600 RC221R End trimmer
- 5246025 Roller inclined at 4° for edge-banding on inclined door surfaces, etc.

Clamping systems (see page 90-94)



Possibility to band straight, circular or shaped pieces.

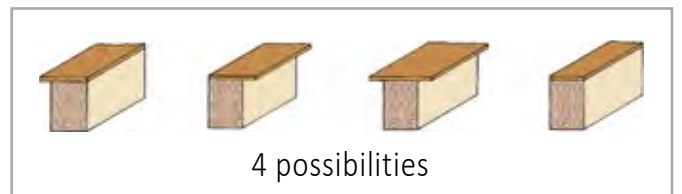

Specifications

Input power	1,500 W
Maximum banding width (1 mm thickness)	50 mm
Maximum banding width (3 mm thickness)	25 mm (pre-cut strip)
Temperature	I: 300°C II: 525°C
Air delivery	400 l/min
Weight	2.8 kg





AU93 | Double edge trimmer

Cuts both sides simultaneously. For edges up to 40 mm. For larger edges it can be used as two independent edge trimmers. Top quality long life blades which are easy to replace once worn.



Trims both sides simultaneously.



RP28 | Scraper-Edge trimmer

For trimming the excess of tapes. Provides a professional finish removing the remains of glue or burrs. It can cut in straight tapes or on radius up to 1.5 mm thickness. Made of high strength treated steel, has a cutting edge of high durability. Guide for an accurate and stable trimming. The blade can be replaced (ref. 2831022).



Scraper

To eliminate the excess of glue and obtain a perfect finishing. (Ref. 5031110)



Blades

2850083 Set of 6 blades for AU93

Specifications

Max. tape width	unlimited
Max. tape width for simultaneous trimming	40 mm
Max. tape thickness	0.6 mm



RC21E | Manual end trimmer

It allows a perfect, clean and high quality cut on all the corners of the board. No other finishing operations are needed. Equipped with twin use blades. For trimming PVC, melamine, Polyester, veneer, etc. up to 0.6 mm thickness



Clean precise cut.

RC221R | Manual end trimmer

For cutting the excess of tape at both ends of panel. It provides a clean and exact cut, avoiding to damage the panel already banded. For cutting tapes on PVC, melamine, polyester, veneer, etc... up to 45 mm width and 2 mm thick. The blades can be sharpened. Possibility to regulate the cutting position.



Clean and exact cut.

Spare blades
2131101 Blade RC221R

Blades
2150112 Set of blades for RC21E

1. Front trimming on one side.
2. Front trimming on some or all the sides.
3. Trimming of the corner with the FR156N trimmer (see page 26).

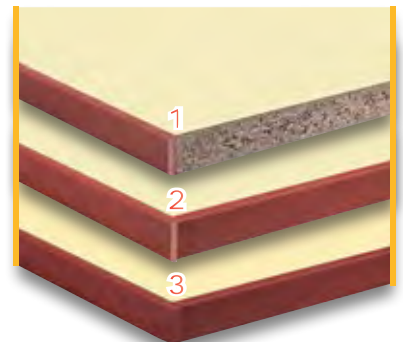

Specifications

Max. tape width	54 mm
Max. tape thickness	0.6 mm

Specifications

Max. tape width	45 mm
Max. cutting width with 1.5 mm tapes	45 mm
Max. cutting width with 2 mm tapes	35 mm



doble

RC321S | Hand end trimmer for 3 mm tapes

For cutting the excess of PVC, melamine, polyester, veneer, etc. tapes up to 45 mm width and 3 mm thick at both ends of panel. It provides a clean and exact cut, avoiding to damage the panel already banded. The guillotine system allows to cut the tape without effort. The blades can be sharpened. Possibility to regulate the cutting position. It enables precise angular cutting up to 60°.



Cutting on both sides on straight panels.



Cutting on circular panels.

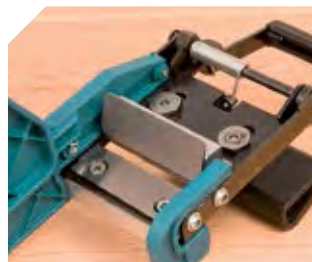

Cutting system with two blades.

Spare blades

- 5231097 Movable blade
- 5231099 Fixed blade

RC421 | Hand end trimmer

For tapes up to 3 mm
Ergonomic and light
It provides a clean and exact cut without to damage the panel. It cuts the excess of the tape at both ends of the panel without to reverse it thanks to the two fixing knobs. In addition to the cut in right angles it allows also to have a clean cut on open angles until 120° and closed angles up to 45°. For cutting the excess of PVC, ABS, melamine, veneer... tapes



Effortless, exact and stable cut thanks to the cutting lever and the two fixing knobs.



Cutting system with two blades. Equipped with professional quality blades that can be sharpened.

Equipped with professional quality blades that can be sharpened.

Specifications

Max. cutting width with 1 mm tapes	55 mm
Max. cutting width with 2 mm tapes	45 mm
Max. cutting width with 3 mm tapes	25 mm

Specifications

Max. cutting width	55 mm
--------------------	-------

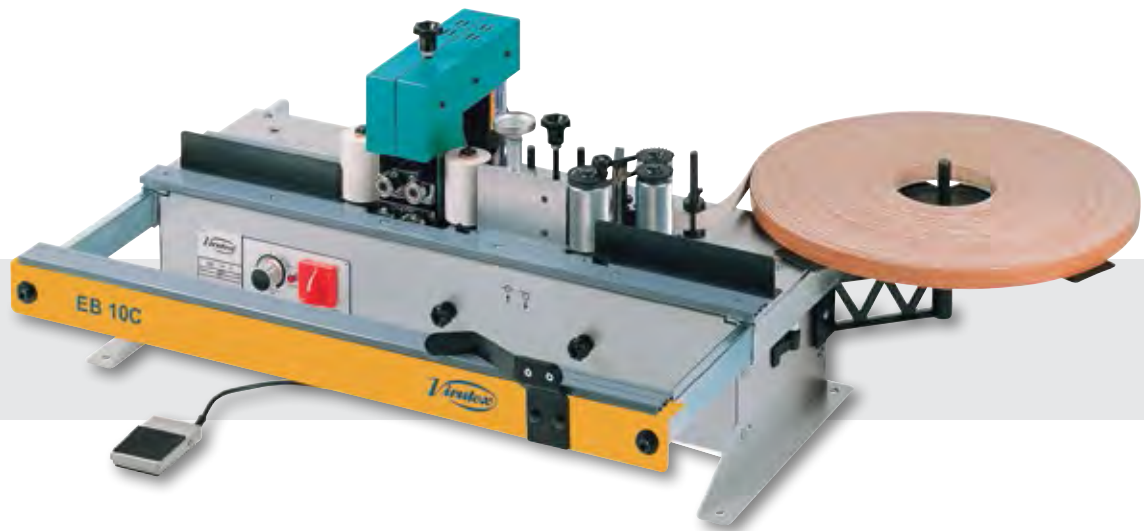

EB10C | Edgebander

For panel edgebanding with pre-glued PVC, melamine and veneer. Powerful hot air system with electronic temperature control. Automatic end trimming. Rapid heat up time (2 min). No compressed air or dust collector required. Equipped with motorized trimming unit on both sides.



Power trimming unit: Trimming strip on both sides simultaneously.



Electronic temperature regulation.



Banding curved pieces.

Optional accessories

6399082 Cantspray

8599694 Netspray

Pre-gluer for tapes (see pages 117-118)

Standard equipment

Foot pedal for rear end trim
for curved pieces

AK97NW Motorized trimming
unit

Specifications

Input power	2,850 W
Min. panel thickness	7 mm
Max. panel thickness	65 mm
Electronic temp. control	0°-500°C
Dimensions	600x950x430 mm
Weight	35 kg





EB25 | Edgebander

For panel edgbanding with pre-glued PVC, melamine and veneer. Automatic edge feeding system. Trimming on both sides. Motorized top and bottom trimming unit. Front edge trimming, rear flush cutting of the tape. No compressed air or dust collector required. Powerful hot air system with electronic temperature control. Minimum heat up time (2 min). Belt feeder for automatic workpiece.



Safety control (STOP). Electronic temperature control.



Power trimming unit: trimming both sides simultaneously.



Feed unit: feeding of the workpiece to be edged.

Single phase 220-240 V
No compressed air required.



End cutting of front and back of the tape.

Optional accessories

PR25P Pre-gluer for tapes
(see page 117-118)
6399082 Cantspray
8599694 Netspray.

Standard equipment

Motorized trimming unit
Belt feeder
Table extension



Cantspray and Netspray

CantSpray is a non-adherent silicone free spray for all movable parts of the edgbanding machines (trimming bits & end cutting blades). It helps to keep clean all the elements from the adhesive residue, which ensures the perfect final performance of the machine. It's silicone-free, so it doesn't leave grease marks on the used materials and doesn't interfere with afterwards treatments (painting, lacquering, varnishing, etc).

NetSpray is a multi-purpose cleaner for effortless removal of adhesive residue, glue streaks and other impurities on all kind of plastic surfaces (like PVC, melamine, ABS, etc). Dries quickly without leaving streaks. It's presented in spray and possesses a pleasant citrus aroma.

Specifications

Input power	3,000 W
Min. panel thickness	11 mm
Max. panel thickness	50 mm
Electronic temp. control	0°-500°C
Working speed	4.2 m/min
Dimensions	1,720x950x1.350 mm
Weight	117 kg



EB150 | Automatic edgebanding machine

Edgebanding machine with ZeroLine® technology by pressurized hot air. Thanks to this technology the banding between the panel and the tape is practically perfect, with a seamless joint.

The result is an edgebanding of high quality.

Quick adjustment and starting. In only 2 minutes the machine is ready to start to work.

For PVC & ABS tapes with coextruded or postprocessed active layer.
For tapes up to 2 mm thickness.

Equipped with an automatic feeder. Trimming unit with digital adjustment. Possibility to trim with different radius or 10° chamfer. Excellent finishings without adhesive residue due to the double flat scraper. Automatic front and rear flush cutting.



Simplified and adjustable control panel with ergonomic arrangement of the devices.

Temperature adjustment controlled by microprocessor, which avoids temperature oscillations.



Direct adjustment of the trimming bits and copiers by digital meters.



Trimming unit with digital adjustment. Possibility to trim with different radius or 10° chamfer. Excellent finishings without adhesive residue due to the double flat scraper. Automatic front and rear flush cutting.



Motorised pressure gluing roller. Allows a perfect banding from the beginning of the panel.

Patented system.



The EB150 must be connected to an external dust collection system like our dust collector model AS382L (optional)

“It is possible to band acrylic and lacquered boards”



The EB150 works with low pressure air. It does not need a high performance compressed air system.



Equipped with two auxiliary rollers on the banding table and a presser assembly, to achieve the optimum pressure of the panel against the banding unit. This ensures a correct banding.

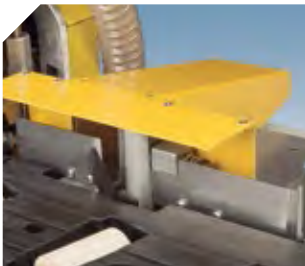

End cutting of front and back of the tape.

Standard equipment

- Belt feeder unit
- Motorised top and bottom trimming unit
- Flat scrapers at both sides of the panel
- Front and rear flush cutting
- Table extension with presser assembly

Optional accessories

- 6399082 Cantspray. Silicone free anti-adhesive spray.
- 8599694 Netspray. Multi-purpose cleaner for effortless removal of adhesive residue.



ZeroLine®

ZeroLine® is a registered trademark of Virutex

ZeroLine® technology

Edge banding machines with pressurized hot air technology for a edgebanding that fuses the edge to the panel, providing a perfect finish and seamless joint.

Glue line with others edgebanding technologies

Zero glue line with ZeroLine® technology.

Perfect finish and seamless joint.

Specifications

Tape thickness	0.4 to 2 mm
Min/max panel thickness	13/45 mm
Min. panel length/width	160/102 mm
Panel feeder speed	4 m/min
Trimming unit speed	10,000/min
Trimming bits Ø	60 mm 4Z R2+10°
Roller holder capacity	590 mm



Bits included as standard equipment

- 8540183 Upper bit Ø 60 Z4, r:2, 10° bevel
- 8540184 Lower bit Ø 60 Z4, r:2, 10° bevel

Optional bits

- 8540185 Upper bit Ø 60 Z4, 45° bevel
- 8540186 Lower bit Ø 60 Z4, 45° bevel

EB140 | Automatic hot melt edgebander

Machin equipped with a PCL controller.

Automatic hot melt edgebander for standard tapes up to 3 mm thickness. The EB140 allows a high quality edgebanding. The adjustment is very easy thanks to its digital meters. The accessibility to the machine parts is fast and comfortable. The machine is equipped with doors and movable elements which make easy all the possible adjustments. Direct adjustment of the trimming bits and copiers. Simultaneous adjustment for the tape thickness, intake guide and gluing roller by a single digital meter. Motorised pressure gluing roller. Allows a perfect banding from the beginning of the panel (patented system). Automatic pneumatic end trimmer for tapes up to 3 mm thickness. No adjustment is required. Trimming unit at 10000/min equipped with adjustable copiers. Panel thickness adjustment by digital meter.



Gluing roller with polymerization processing. Reduces the consumption of glue. Allows to band ABS tapes with 3D and glass effect with the optional roller ref. 8504319.

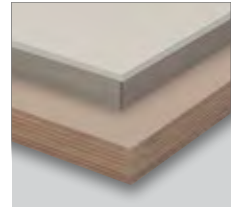

Panel thickness adjustment by digital meter.

Trimming unit at 10000/min equipped with adjustable copiers.

Automatic pneumatic end trimmer for tapes up to 3 mm thickness. No adjustment is required

Powerful panel feeder with wide belt. Optimal feeding of pieces more than 2 m long.

Working table equipped with antifriction material and rubber pressure rollers.

Telescopic frontal extension with rollers.

Video



Touch screen for an easier machine control. Temperature adjustment from 120° to 220°C. Automatic temperature control. ECO mode. Self-checking system. Users management. Operation tutorials.



Motorised pressure gluing roller. Allows a perfect banding from the beginning of the panel. **Patented system.**

Automatic feeder for tape rolls with pneumatic cutting system.

Roller holder for rolls up to 590 mm diameter.



Simultaneous adjustment for the tape thickness, intake guide and gluing roller by a single digital meter.



Glue pot with non-stick Teflón® cover. The amount of glue can be also adjusted.

Teflón® is a trade mark of E. I. du Pont de Nemours and Company

EB140 | Automatic hot melt edgebander



The accessibility to the different parts of the machine is easy and comfortable. The EB140 has several doors and movable elements making easy the different adjustments.



External dust collection for pipes of 100 mm diameter. To be connected to dust collection systems with a minimum air flow of 1000 m³/h.

The EB140 edgebander must be connected to an external dust collection system like our dust collector model AS382L (optional), with a big dust collection capacity and prepared to work during the trimming cycles automatically.

Bits included as standard equipment

- 8540183 Upper bit Ø 60 Z4, r:2, 10° bevel
- 8540184 Lower bit Ø 60 Z4, r:2, 10° bevel

Optional bits

- 8540172 Upper bit Ø 60 Z4, r:3, 10° bevel
- 8540173 Lower bit Ø 60 Z4, r:3, 10° bevel
- 8540185 Upper bit Ø 60 Z4, 45° bevel
- 8540186 Lower bit Ø 60 Z4, 45° bevel

Optional accessories

- 6399082 Cantspray. Silicone free anti-adhesive spray.
- 8599694 Netspray. Multi-purpose cleaner for effortless removal of adhesive residue.
- 8599611 Lubricating oil 30 ml.
- 8546317 Locking kit for end trimmer (for banding laminates)
- 2599266 Container of glue 4 kg



Specifications

Tape height	45 mm for tapes from 0.4 to 2 mm
Tape height	25 mm for tapes of 3 mm
Min/max panel thickness	13/45 mm
Min. panel length/width	140/65 mm
Panel feeder speed	5 m/min
Trimming unit speed	10,000/min
Trimming bits Ø	60 mm 4Z R2+10°

Roller holder capacity	590 mm
Glue pot capacity	1 kg
Working temperature	120-220°C
Feeder motor power	0.18 kW
Trimming unit motor power	0.37 kW
Gluing unit motor power	0.09 kW
Weight	260 kg



Video



PAE85T | Corner round trimmer

Corner round trimmer for the automatic trimming on straight, curved or postformed corners on banded panels.

Thanks to the big bit diameter it is possible to obtain a high quality trimming. Equipped with an extendable guide for bigger pieces.

Guide for positioning the panel to be trimmed in an easy and fast way.

Pneumating presser for fixing the panel during the trimming process.

The copier is independant from the bit to avoid an accidental damage of the panel. Other radius can be possible under order.



Extensible guide for big pieces.



Guiding fence on the side of the tape to be trimmed.



Separate copier from the bit.

Bit included as standard equipment

8540183 Upper bit Ø 60 Z4, r:2, 10° bevel

Optional bits

8540172 Upper bit Ø 60 Z4, r:3, 10° bevel

8540185 Upper bit Ø 60 Z4, 45° bevel

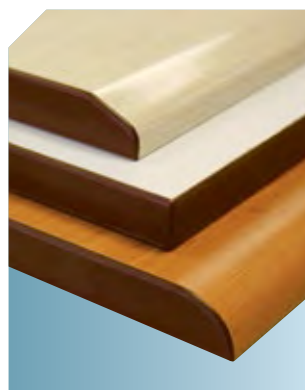

High quality trimming in several kind of corners.



Specifications

Panel thickness min/max	9/45 mm
Min. panel dimensions (with pushing rod)	130 mm x 300 mm / 100 mm x 130 mm
Max. trimming radius	r: 3
Trimming bit (standard)	R: 2 - chanfer 10°

Trimming bit (optional)	R: 3 - chanfer 10°
Bit diameter	60 mm
Bit speed	10.000/min
Voltage	230 V / 50-60 Hz
Working pressure	6 bar

rapid

EB135 | Automatic hot melt edgebander

Fast and compact; it offers a perfect performance at a very competitive price.

Quick start and adjustment. 5 minutes heat up time.

For PVC, melamine, veneer and ABS tapes (included 3D and glass effect). Possibility to use tapes up to 3 mm thick.

Glue temperature adjustment controlled by microprocessor, which avoids the temperature oscillation.

Motorised pressure gluing roller to ensure the perfect edgebanding from the beginning of the panel.

Gluing roller with polymerization processing which helps to reduce the glue consumption.

Glue pot covered by Teflon® for an easy cleaning and maintenance.

Excellent finishings without adhesive residue due to the double flat scraper.

High performance. Up to 120 m of continue edgebanding with the glue pot content.

Panel thickness from 13 up to 50 mm. Suitable for lightweight panels as well.



Video



Single phase 220-240 V
No compressed air required.

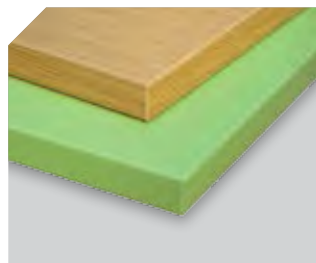

Excellent finishings with different kind of tapes.



Edgebanding of lightweight panels.

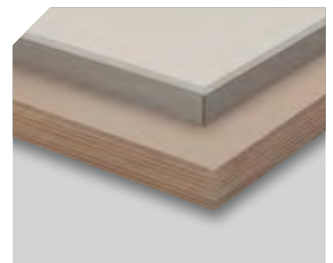

For ABS tapes with 3D and glass effect.



To ensure the tape is well banded, the EB135 is equipped with an automatic feeder for assisted and effortless edgebanding.

Thanks to the two auxiliary rollers on the banding table and a special pressers set, we achieve the optimum pressure of the panel on the banding unit. This ensures a correct banding, specially when using thick and rigide tapes.



Easy cleaning and maintenance:
Glue pot and tape sliding base are covered by Teflon® for an easy cleaning and maintenance.

Teflon® is a trade mark of E. I. du Pont de Nemours and Company

Fast and easy adjustment. Perfect performance.
Minimum maintenance.



Simply display screen. Glue temperature adjustment controlled by microprocessor, which avoids the temperature oscillation.



Trimming unit with digital adjustment. Possibility to trim with different radius or 10° chamfer. Excellent finishings without adhesive residue due to the double flat scraper. Automatic front and rear flush cutting.

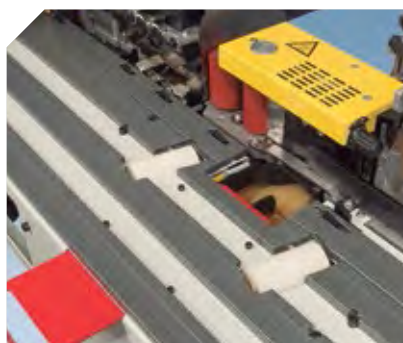

Motorised pressure (gluing) roller. Optimum capacity of the glue pot. Easy to reload and to maintain clean thanks to its Teflon® cover.



Easy to reload thanks to the special chute. It's equipped with dispenser to reload the glue while working, with no need to stop the machine.



Simple and fast tape thickness adjustment. It allows tapes up to 3 mm thick.



Precise control of the glue dosage on the tape, which helps to adapt correctly the performance of the machine to different kind of materials.

Standard equipment

- Belt feeder unit
- Motorised top and bottom trimming unit with TCT bits r=2 + 10° chamfer
- Flat scrapers at both sides of the panel
- Front and rear flush cutting
- Table extension

Bits included as standard equipment

- 8540183 Upper bit Ø60 Z4, r:2, 10° bevel
- 8540184 Lower bit Ø60 Z4, r:2, 10° bevel

Optional bits

- 8540172 Upper bit Ø60 Z4, r:3, 10° bevel
- 8540173 Lower bit Ø60 Z4, r:3, 10° bevel
- 8540185 Upper bit Ø60 Z4, 45° bevel
- 8540186 Lower bit Ø60 Z4, 45° bevel

Optional accessories

- 8200300 AS382L Dust collector, equipped with two motors and prepared to work during the trimming cycles automatically.
- 8545498 Attachment with connectors Ø ext. 38-100 mm For general dust collection systems with a minimum capacity of 1000 m³/h.



2599266 Container of glue 4 Kg



6399082 Cantspray. Silicone free anti-adhesive spray.

8599694 Netspray. Multi-purpose cleaner.

Specifications

Input power	3,450 W
Min. panel thickness	13 mm
Max. panel thickness (for tapes from 0.4 to 2 mm)	50 mm
Max. panel thickness (for 3 mm tape)	25 mm
Min. panel width	102 mm
Min. panel length	180 mm
Adjustable working temperature.	110°-200°C

Working speed	4 m/min
Trimming unit no-load speed	10,000/min
Trimming bits	Ø 59, Z4, R2, +10°
Voltage (single phase)	220-240 V
Dimensions	1,720x950x1,350 mm
Weight	150 kg



PEB250+ | Hot melt portable edgebander

Hot melt portable edgebander. For PVC, ABS, melamine, laminate or veneer tapes, previously cut to the wanted length, on straight, round or shaped panels. Very practical for small manufacturing series due to its easy operation and fast adjustment. The height tape adjustment and panel thickness is very easy and intuitive. Equipped with assisted tape feeding and electronic speed control to work at the most convenient speed. With electronic temperature control the machine is also equipped with a precise control for the glue dosage on the tape. Glue pot and tape sliding base covered by Teflon® for an easy cleaning and maintenance.

Video



Precise control of the glue dosage on the tape.



Gluing roller with polymerization processing. Allows to band ABS tapes with 3D and glass effect.

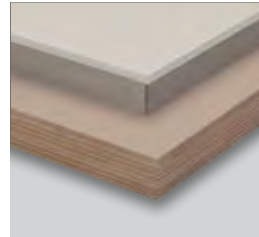

Adjustable exit tape guide. Guarantees the position of the tape regarding the panel.



Adjustable infeed guide.

Adjustable tape thickness for a better glue smoothness.



Temperature adjustment (120 to 200°C) controlled by microprocessor for higher accuracy on measurement. Temperature increasing by impulses. Protects the heating elements increasing their working life.



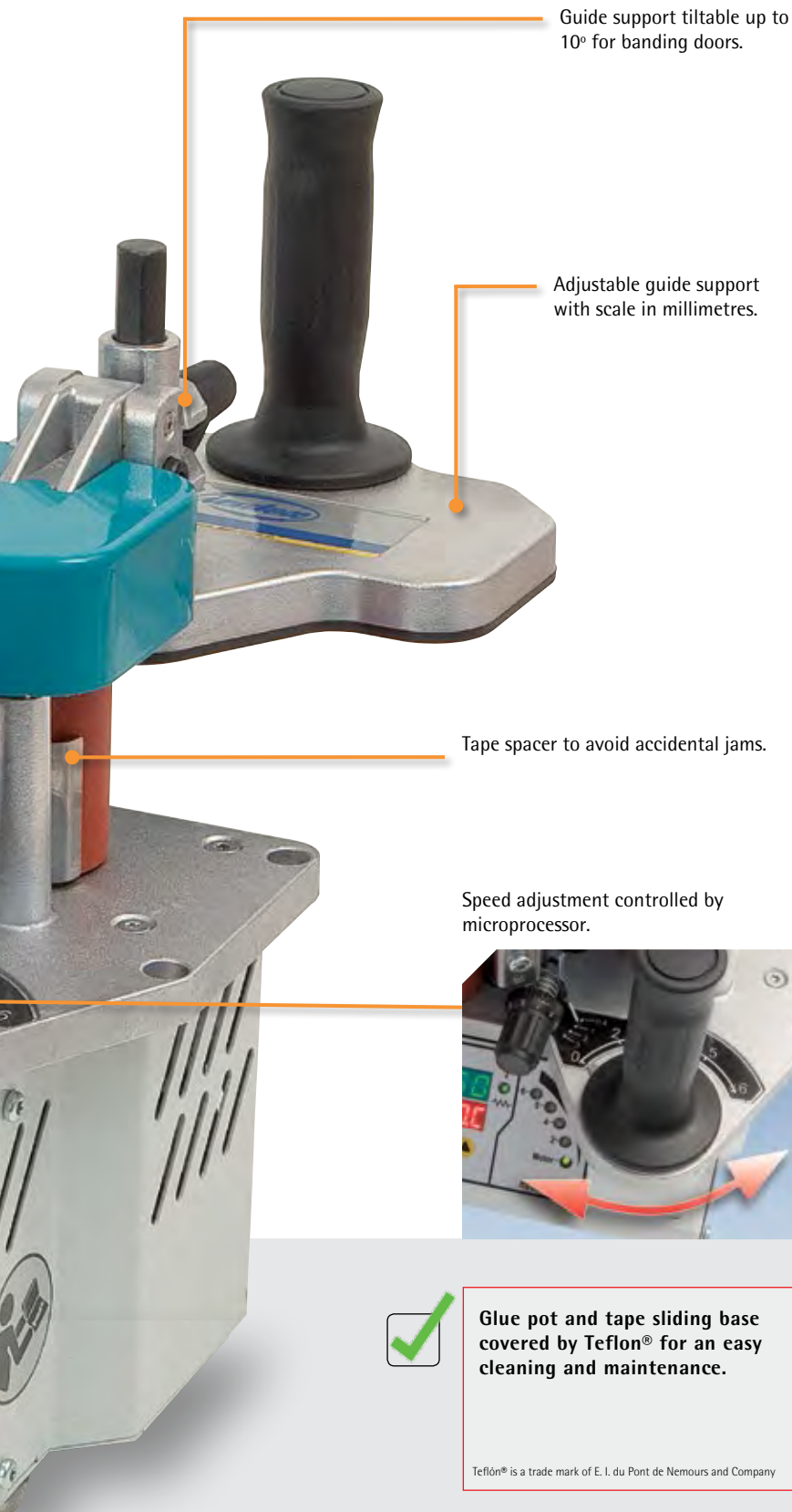

Guide support tiltable up to 10° for banding doors.

Adjustable guide support with scale in millimetres.

Tape spacer to avoid accidental jams.

Speed adjustment controlled by microprocessor.



Glue pot and tape sliding base covered by Teflon® for an easy cleaning and maintenance.

Teflon® is a trade mark of E. I. du Pont de Nemours and Company

Other models

Model PEB200 without electronic speed nor temperature adjustment.



Optional accessories

5046845 Table MEB100 (for PEB50/150/200/250)



5046862 Roller ass'y MEB100



5046525 Table MEB250 for stationary operation.

5046586 MEB250A Table for stationary operation, with automatic rear tape cutting and roller holder.



5046266 Set roller holder & end trimmer.

5046686 MI250 Tilting table.

5046703 AK97NW set for MEB250A.

5046704 Guide extension for MEB250A.

5046705 RP80 presser roller set.

2599266 Container of glue 4 kg

6399082 Cantspray, silicone free non-adherent spray to avoid the glue to stick on the rollers.

8599694 Netspray, multi-purpose cleaner for effortless removal of adhesive residue.



5046764 Auxiliary roller

Easy and fast to install on the edge bander, it allows an ideal banding on difficult places, like corners or concave shapes with a close radius.

Specifications on page 115

PEB250TRM | Hot melt edgebander with stationary table

Hot melt edgebander with stationary table. For PVC, ABS, melamine, laminate or veneer tapes, on straight, round or shaped panels. Very practical for small manufacturing series, especially on straight panels. Easy operation and fast adjustment. Table with extending frontal guide to work with total stability. The height tape adjustment and panel thickness is very easy and intuitive. Equipped with assisted tape feeding and electronic speed control to work at the most convenient speed.

With electronic temperature control the machine is also equipped with a precise control for the glue dosage on the tape.

Glue pot and tape sliding base are covered by Teflon® for an easy cleaning and maintenance.

It's equipped with roller holder and automatic rear tape cutting.

The glueing unit can be used as a portable edgebander just taking away the three screws which fix it to the table.

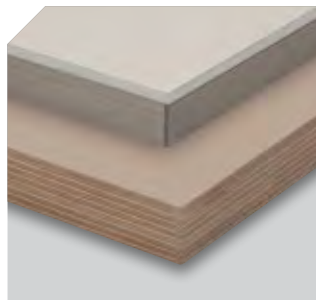
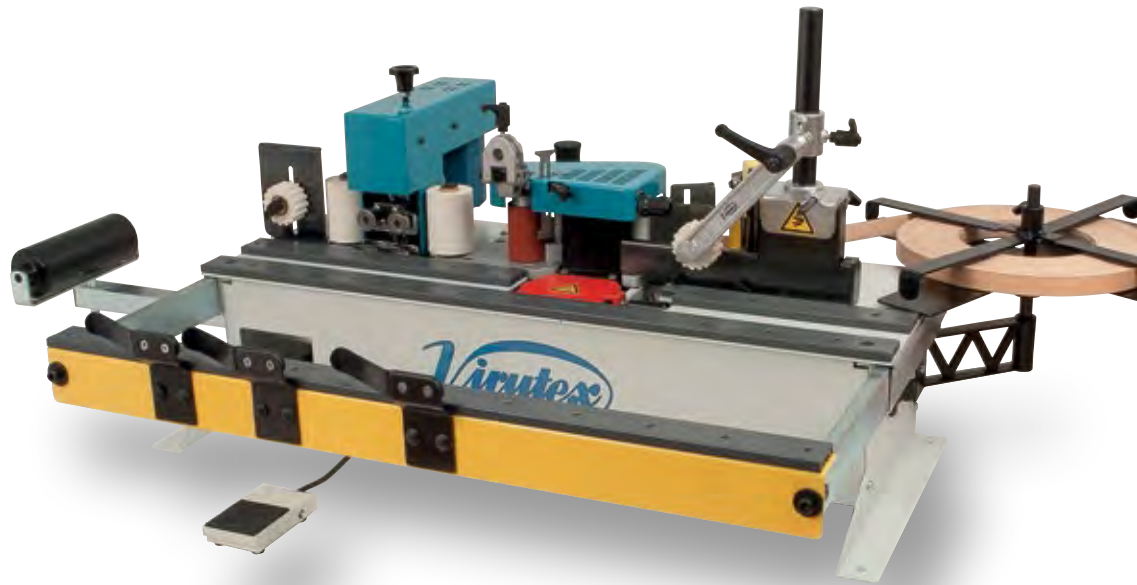

Gluing roller with polymerization processing. Allows to band ABS tapes with 3D and glass effect.



Speed adjustment controlled by microprocessor.



Temperature adjustment (120 to 200°C) controlled by microprocessor for higher accuracy on measurement.

Temperature is rising by impulses, which protects the heating elements and increasing their working life.



Video



Rear connecting box to plug in the PEB250+ and a panel feeder. The table has the corresponding holes for its fixation. (Models PEB250TRM and PEB250TA)



Extending frontal guide to work with a total stability.



Easy banding of shaped and round panels.



Automatic rear tape cutting. Foot pedal for curved or shaped pieces.



Trimming unit for tapes up to 1 mm thickness.

EB58K | Movable working table



Table dimensions	840x350 mm
Working height	810, 734, 621 and 383 mm
Masupported weight	100 Kg

PEB250TA



Hot melt glue pot edge bander with automatic rear tape cutting. Foot pedal for curved or shaped pieces.

Optional accessories:

Motorized trimming unit.
Guide extension.
Panel presser.

PEB250TRC | PEB200TRC



Model with similar features as the PEB250TA but with rear manual end cutting.

Model PEB200TRC without electronic speed nor temperature adjustment.

Standard equipment

PEB250TA, PEB250TRM, PEB250TRC,
PEB200TRC
Bag of glue 250 gr.

Optional accessories see page 118

Specifications

PEB250+, PEB200, PEB250TA, PEB250TRM, PEB250TRC, PEB200TRC

Input power	830 W
Adjustable working temperature ¹	120-200°C
Working temperature ²	170°C
Adjustable working speed ¹	2, 4, 5 and 6 m/min
Working speed ²	3.6 m/min
Panel thickness	10-62 mm

Tape thickness	0.4-3 mm
Tank capacity	230 cm ³
Weight PEB250 and PEB200	9 kg
Weight PEB250TA, PEB250TRC and PEB200TRC	30 kg

(¹) PEB250+, PEB250TA y PEB250TRC (²) PEB200 and PEB200TRC



Optional accessories

PEB250TA, PEB250TRM, PEB250TRC, PEB200TRC

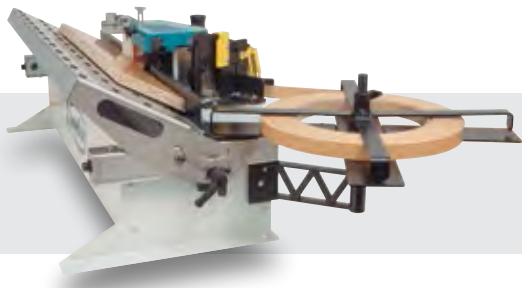

MI250 Tilting table. For gluing panels with a lean from 15° to 50°.

- 5600510 FR256N Edge trimming set
- 2800000 AU93 Edge trimmer
- 2100000 RC21E End trimmer
- 2100600 RC221R End trimmer (2 mm)
- 5245922 RC321S End trimmer (3 mm)
- 6399082 Cantspray
- 8599694 Netspray
- 2599266 Hot melt container 4 Kg.
- 5031110 Scrapper
- 5846351 EB58K Working table



5046703 AK97NW edge trimmer + pressers +roller (for MEB250, MEB250A).



5046266 Tape cutter and roller holder ass'y RC50T (for MEB250, MEB100)



5046704 Guide extension (for MEB250, MEB250A).



5046705 RP80 presser + support (for MEB250A).

Hot melt glue

Special for Virutex edgebanders with glue pot.

For a good and durable banding we recommend to use our hot melt glue. Only using our special glue we can guarantee the correct operation of our machines.



2599266 Container of 4 Kg of hot melt glue for EB135, EB140, PEB250, PEB200, PEB250TA, PEB250TRC and PEB200TRC.
Working temperature: 150-170° C
Good adherence and heat resistance.

CantSpray



Cantspray is a non-stick product without silicone for edgebanders. It avoids that rest of glue adhere to the trimming blades, front and rear cutting and other parts of the edgebander. It maintains these parts in an optimal condition of work. It does not contain silicone in its composition, so it does not grease nor it stains the parts of the machine or the pieces to be banded. It avoids, in the banded pieces, problems in after-treatments of painted, lacquer, varnished or other processes.



NetSpray



Netspray is a very effective multipurpose cleaner for cleaning rests of glue. It dissolves the persistent dirt, oil, fat, wax, tar, rubber, marks of wearing down, as well as silicone residues or glue. It is also an effective degreaser. It eliminates residues of self-adhesive labels and he is very effective in the previous cleaning to the positioning of adhesives. It does not irritate the skin and it has an pleasant citric scent.



Pre-gluer for tapes



PR25P-DV | Automatic hot melt pre-gluer

Automatic, low maintenance, hot melt edge pre-gluer, for pre-gluing materials such as: plastic or wood laminate strips, layered strips, 0.4 to 3 mm PVC, ABS, polyester, melamine or wood veneer tapes. Like the PR25P, it automatically glues tapes for later use with edgebanders for pre-glued tapes, as manufactured by Virutex, or with any hot air edgebanding machines. It has thermoelectric temperature control, automatic start and stop of the feed motor, depending on the glue temperature, and an accurate dosage mechanism which dispenses the exact amount of glue to obtain the required density on the back of the tape. It has a built-in, automatic winder which easily unwinds rewinds it already glued with no risk of accidental gluing, thanks to the built in drying unit. It has a low maintenance, non-stick silicon dispenser roller which prevents glue blockages.

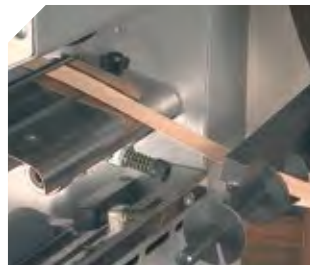

High quality pre-gluing.



Pre-gluing strips.



Easy access glue tank on top. The glue application system includes an easy, non-stick silicon roller.

Optional accessories

Optionally, the machine can be fitted with a triple winder (2545633) for pre-gluing up to three edges at the same time (edges with the same thickness). This triples the machine's production capacity, that is very important for users who wish to create a stock of pre-glued edges. (contains: 4 reel loading discs, 4 reel centering discs, assembly booklet and instructions). **A**



Standard equipment

Automatic winder, 2 multidiameter reel centering devices, 1 kg of glue and a cardboard roll centre ring.

- 2502522 Multi-diameter reel centring device (2 units included with standard equipment) **B**
- 2545659 Pack of 25 Ø 85-mm cardboard rings for edge roll centres **C**
- 2545660 Pack of 25 Ø 150-mm cardboard rings for edge roll centres **C**
- 2599242 Hot melt glue, 1 kg bag

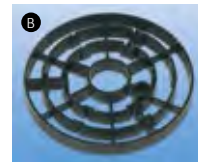

Specifications

Input power	1720 + 120 W
Minimum tape thickness	0.4 mm
Max. tape thickness: strip/roll/roll+support 2545632	16/2/3 mm
Maximum tape width	104 mm
Feeding speed	510 m/h=8.5 m/min
Tape pre-glued with 1 Kg of glue	250 m of tape 25 mm width
Tank capacity	2 kg of glue
Weight	37.8 kg

Optional

2545632 Support for large rolls. Ideal for 2 and 3-mm thick edge rolls.





PR25P | Pre-gluer for tapes

Low maintenance, hot melt edge pre-gluer for pre-gluing materials such as: plastic or wood laminate strips, layered strips, 0.4 to 2 mm PVC edges, ABS, polyester, melamine or wood veneer tapes.

The machine glues tapes for later use with edfebanders for pre-glued tapes, as manufactured by Virutex, or with any hot air edgebanding machines.

It has thermoelectric temperature control, automatic start and stop of the feed motor, depending on the glue temperature, and an accurate dosage mechanism which dispenses the exact amount of glue to obtain the required density on the back of the tape. It consumes between 160 and 200 g of glue per sqm. It has a built-in manual winder which lets the original roll easily unwind and then rewinds it with the tape already glued and ready for use. Using the optional kit, two similar tape rolls can be pre-glued at the same time.



Easy to handle and start, allows rolls to be preglued without complications.



High quality pre-gluing.



Pre-gluing strips.

Optional accessories

2545631 Double winder for the manual PR25P. Simultaneously pre-glues two edge rolls with the same thickness (contains: 4 reel loading discs, 8 reel centring devices, assembly and instruction manual). **A**



2545628 DV25P Automatic winder. Kit to convert the manual PR25P into an automatic PR25P-DV.



Standard equipment

Manual winder, 2 multidiameter reel centering devices, 1 kg of glue and a cardboard roll centre ring.

2502522 Multi-diameter reel centering device (2 units included with standard equipment) **B**

2545659 Pack of 25 Ø 85-mm cardboard rings for edge roll centres **C**

2545660 Pack of 25 Ø 150-mm cardboard rings for edge roll centres **C**

2599242 Hot melt glue, 1 kg bag

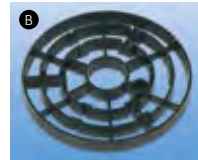

Specifications

Input power	1,720 W
Minimum tape thickness	0.4 mm
Max. tape thickness (strip)	16 mm
Max. tape thickness (roll)	2 mm
Maximum tape width	104 mm
Feeding speed	510 m/h=8.5 m/min
Tank capacity	2 Kg of glue
Weight	26 kg



www.virutex.es



2019 | 2020



Printed in Spain | 04/2019



Av. de la Llana , 57
E-08191 Rubí (Barcelona) Spain

Tel. +34 934 329 888
E-mail export@virutex.es
www.virutex.es